



# iFIX

One Part – One Click

Photovoltaic flat roof mounting system for south-facing orientation

Assembly instructions | Version 05/2024

## ASSEMBLY INSTRUCTIONS

### iFIX SOUTH

### VERSION 2024

---

**The smart substructure for  
photovoltaic systems on flat roofs**







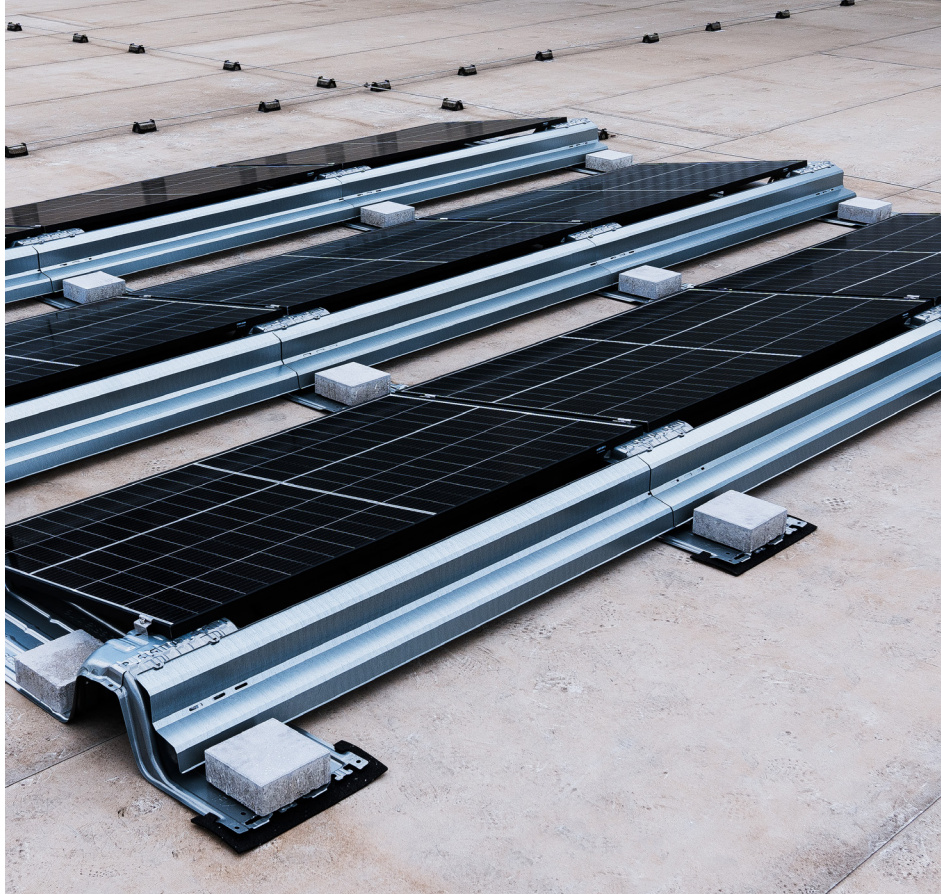

# CONTENTS

---

Features of iFIX S	4
Important planning notes	5
General assembly and safety instructions	6
Tool overview	9
Key components required	10
Assembly steps	11
Maintenance	14
Warranty	14
Accessories	15

## FEATURES OF iFIX S

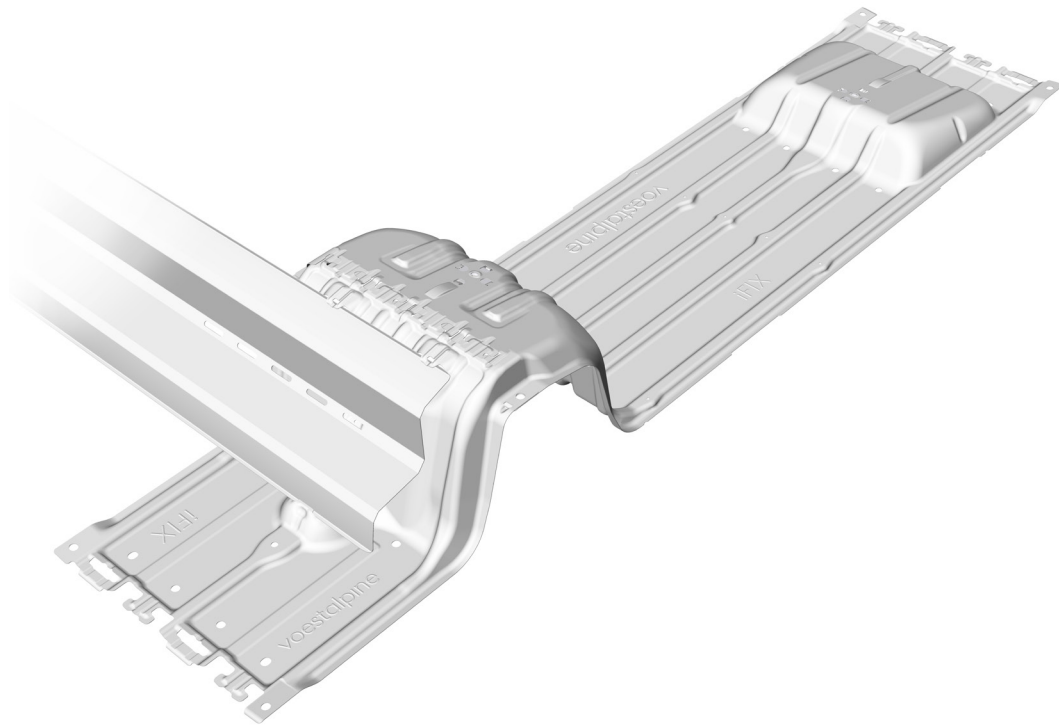

- » Tool-free connections between rows through a unique click-locking mechanism
- » Wind deflector can be mounted without tools by simply sliding it in
- » Fastening points designed for invisible cable routing underneath the PV modules
- » Universal centre clamps and matching end clamps with pre-fixed Allen screw for all PV module frame heights
- » Matching building protection mats are pre-assembled or can be attached to the sheet metal
- » Thermal separation between the rows is not required
- » Also suitable for use with soft roof insulation due to large footprint



## IMPORTANT PLANNING NOTES

- » iFIX S is currently suitable for buildings with a closed building front. Others upon individual inspection.
  - » iFIX S can be used on all standard flat roofs with a pitch of 0 to 3° where there is no permanent standing water. Up to 5° with special on-site measures.
  - » Acceptable substrates: Bitumen, plastic film, gravel, green roof (sheet metal and others after individual testing)
  - » Building height up to 25 m
  - » Application areas:
    - Pressure load up to 3.8 kN/m<sup>2</sup> \*
    - At least 3 km from the sea
    - Gust velocity pressure up to 1,400 N/m<sup>2</sup> \*
  - » Minimum distance iFIX S main sheet to roof edge 0.50 m. No parapet required.
  - » The PV modules on the roof must be installed in blocks of at least 2, i.e., 2 PV modules in a row or next to each other.
  - » Calculation of the required iFIX mounting units (1x iFIX EW + 1x iFIX S connector) per row: Number of PV modules + 1
  - » Calculation of the row length (east-west): (largest PV module length + 20 mm) x number of PV modules in series + 380 mm
  - » Calculation of the field length (north-south): 1,620 mm x number of rows + 20 mm (short connector), 1,810 mm x number of rows + 20 mm (long connector).
  - » Field separations due to thermal length changes: The field must be separated after a maximum of 14.5 m in the row (east-west direction). This should measure at least 0.5 and max. 1.3 m between the PV module ends. For larger distances, separate fields must be assumed for the ballast calculation. Between rows (north-south direction) no field separation is required.
  - » Applicable PV module sizes:
    - Width: min. 990 mm, max. 1145 mm
    - Length: min. 1650 mm, max. 2100 mm
    - Frame height: 30–40 mm
- The PV module dimensions must not exceed an area of 2.17 m<sup>2</sup> and a width of 1,145 mm.
- » To ensure long-term protection of the roof cladding and the iFIX S sheets, their compatibility with one another must be checked (see assembly instructions). The underside of the iFIX EW main plate must be fitted with building protection mats, as the iFIX S Connector is only available with pre-assembled aluminium-laminated building protection mats.
  - » During the design phase, it is important to check whether the roof insulation can bear the additional pressure load caused by the weight of the PV system, weighting and pressure loads. To ensure protective transfer of the system loads to the roof surface and the insulation, the EW and South sheets are offered with pre-assembled building protection mats (contact surfaces: Compact 0.112 m<sup>2</sup>, Extended 0.120 m<sup>2</sup>). The largest possible contact area can be achieved using the iFIX EW Base (without building protection mat) and the large building protection mat (iFIX Base Protect) (contact areas: Compact 0.308 m<sup>2</sup>, Extended 0.316 m<sup>2</sup>).
  - » A ridge superstructure may only be added if the buckling line runs in the area of the hooking.
  - » Roof surface recesses may not be covered. A field separation is required.
  - » Depending on the position of the building, wind and snow loads and the height of the building, the system must be secured against lifting and moving. For this purpose, weights must be placed as weights on the designated areas according to a weighting plan individually created by the system provider.
  - » On-site, the system must also be secured during installation, especially if there are no modules and wind deflectors yet.
  - » In general, care must be taken to ensure correct hooking.
  - » In case disassembly is necessary, we recommend the procedure described in our disassembly video.
  - » Additional accessories such as Alpine supports can be supplied optionally.



# GENERAL ASSEMBLY AND SAFETY INSTRUCTIONS

## STRUCTURAL ENGINEERING

Prior to installation, the client should check whether the building and roof meet the additional static requirements of the iFIX system regarding horizontal and vertical loads. The Eurocode 3 standard (DIN EN 1993) must be observed. The required ballast can be found in the system provider's individual weighting plan. The complaint plan may only be drawn up by trained personnel. The iFIX Tool calculation program for determining the weighting is available for this purpose, and is based on a wind load report and the system statics of a state-approved structural engineer.

Should the structural design of a system be carried out by the client themselves, the structure, design and stability of the construction must be carried out in accordance with:

EN 1991-1-3 Snow loads (Eurocode 1)

EN 1991-1-4 Wind loads (Eurocode 1)

Calculations must be carried out in accordance with the latest civil engineering standards.

National and site-specific building regulations, standards and environmental protection regulations must be complied with.

## SAFETY

Work safety and accident prevention regulations, corresponding standards and regulations of the employers' liability insurance association must be adhered to!

Those are:

BGVA1 General accident prevention regulations

BGVA3 Electrical systems and equipment

BGVC22 Safety regulations for construction work

DIN 18338 Roofing works

DIN 18451 Scaffolding works

In particular, the following should be noted:

- » Wear protective clothing (especially safety helmet, work shoes and gloves)
- » For roof works, the regulations for working on the roof must be observed (e.g. use of: Fall protection, scaffolding with safety gear from an effective eaves height of 3 m, etc.)
- » For the entire installation process, the presence of two people is essential to ensure rapid assistance in the event of an accident.
- » Any necessary roof work must be carried out by a roofer.
- » AC/DC wiring must be carried out by an electrician. The following must be considered:  
DIN VDE 0100 Part 712 – Installation of low-voltage systems and other relevant regulations applicable on site.

## MOUNTING

PV systems may only be installed and commissioned by **individuals** who are able to ensure that the work is carried out in accordance with the regulations due to their **professional suitability** (e.g. training or activity) or experience.

Please ensure that at least one copy of the **assembly instructions** is available on site and observed throughout the entire installation period.

iFIX is under constant development. As a result, assembly sequences may change. When installing, it is therefore essential to use the latest version of the installation instructions.

**Current documents** are available at [www.voestalpine.com/iFIX](http://www.voestalpine.com/iFIX)



Prior to installing the PV system, it must be ensured that the roof waterproofing complies with DIN standard 18531. To prevent long-term damage, the compatibility of the roof surface with iFIX must be checked. A protective mat under the iFIX sheets is not required for gravel roofs, as long as the iFIX sheets are placed on the gravel. iFIX sheets with protective mat cut-outs must be used for bituminous roof waterproofing. Should the roof cladding consist of plastic foil, iFIX sheets with aluminium-laminated protective mat blanks shall be used to prevent the roof cladding from becoming brittle.

The film's compatibility with the protective mat must be approved by the film manufacturer. Fleece mats are not allowed as a carpet pad and are a hazard! Where there are localized recesses in the roof cladding that lead to puddles forming, differences in height should be compensated for by placing underlays suitable for the respective roof cladding.

If iFIX sheet metal parts are cut to size on site, ensure that their stability is not impaired and that cut edges are treated in such a way that there is no risk of injury to persons or the roof cladding from sharp corners and edges.

The assembly instructions of the PV module manufacturer must be adhered to so that the PV module is only clamped in the areas approved by the PV module manufacturer.

Avoid conductor loops when laying cables under the PV modules.

Furthermore, the following standards must be complied with:

- VDS 2023 Electrical Installations in buildings with predominantly combustible materials – Guidelines for loss prevention
- DIN 4102 Behaviour of building materials and components in case of fire
- DIN 1860 Drainage systems for buildings and land

In the event of disregard of our assembly and safety instructions and the installation or attachment of competitor components, voestalpine Automotive Components Schwäbisch Gmünd GmbH & Co. KG reserves the right to exclude liability.

## **EARTHING / EQUIPOTENTIAL BONDING**

Before commissioning, the system must be connected to the building's equipotential bonding. All components within a module row are conductively connected to each other via the interlocking of the module clamps, so that one connection per row (up to modules) is sufficient. It may be necessary to connect parts of the system to the external lightning protection, depending on the situation on the roof.

## **LIGHTNING CURRENT CARRYING CAPACITY**

As a rule, the lightning protection of a PV system or the building below it must be planned by a lightning protection specialist. In this context, the term lightning current carrying capacity is used for connections, terminals etc. that must actively discharge lightning currents as part of the lightning protection system. Each of these components must be tested and certified separately. Generally, the lightning current carrying capacity of a support system is not relevant for this problem, since the support system is not used as an arrester or air-termination rod in the context of external lightning protection. The lightning protection system should be designed completely independently of the PV system. In general, a defined separation distance must be maintained between the PV system and the lightning protection system.

In particular cases, connecting the rack system to the lightning protection system is permissible, but the coupling of partial lightning currents into the electrical system must be taken into account.

In these cases, it is important that the internal potential connections of the rack are connected with a low resistance and a sufficient cross-section. See separate "Notes on equipotential bonding and lightning protection".



The standards to be complied with for the design and installation of lightning protection, earthing and equipotential bonding:

- DIN EN 62305 Lightning protection
- DIN VDE 0185 Part 1-4 Lightning protection (especially Part 3, Supplement 5)
- DIN VDE 0100 Part 410 Grounding
- DIN VDE 0105 Operation of electrical systems
- DIN VDE 0298 Electrical wiring

To ensure safe and proper installation of the system, please read through all the installation steps first. The required material is listed for each step.

Find out more about iFIX  
and visit us at  
[www.voestalpine.com/iFIX](http://www.voestalpine.com/iFIX)



## TOOL OVERVIEW

---

### Protective gloves

EN 388 – Protection class min. 4431



---

### Measuring tape

About 3.0 m



---

### Impact cord

About 6.0 m



---

### Cordless screwdriver

Allen bit: 8 mm



---

### Torque wrench

Allen bit: 8 mm

Adjustable from 2 to 14 Nm



---

### Bit for iFIX S earthing connector

EJOT LT/STS Tool Plastic TX25



---

### iFIX Spacer



---

### Cable ties

UV-resistant





## KEY COMPONENTS REQUIRED

### iFIX Base / Protect / Alu-Protect

Dimensions: 1,218 x 376 x 227 mm

Weight: 3.236 kg

Material: corrosion-protected zinc-magnesium-coated sheet steel

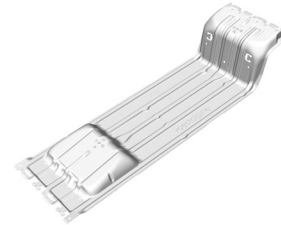

### iFIX S Connector Extended

Dimensions: 643 x 376 x 227 mm

Weight: 2.22 kg

Material: corrosion-protected zinc-magnesium-coated sheet steel

OR

### iFIX S Connector Compact

Dimensions: 453 x 376 x 227 mm

Weight: 1.95 kg

Material: corrosion-protected zinc-magnesium-coated sheet steel

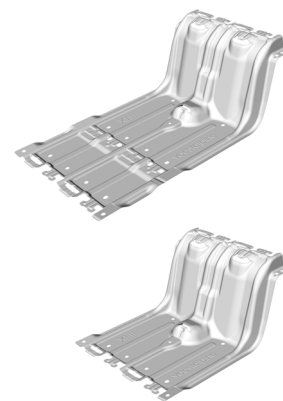

### iFIX centre clamp

2 units per PV module

with pre-fixed screw



### iFIX end clamp

2 units per row end

with pre-fixed screw to match the frame height of the PV module



### iFIX S grounding connector

1 unit per iFIX S Connector



# ASSEMBLY STEPS

## STEP 1

### Laying out iFIX sheets

Alternately latch the iFIX Base to the S Connector at the markings, forming rows of metal sheets. Define the distance using the spacer. For use of the spacer, see page 16.

Material: Measuring tape, impact cord, iFIX Base, iFIX S Connector

Hint: If iFIX Base is used with iFIX Base Protect, fit the building protection mat at the same time (see page 15).

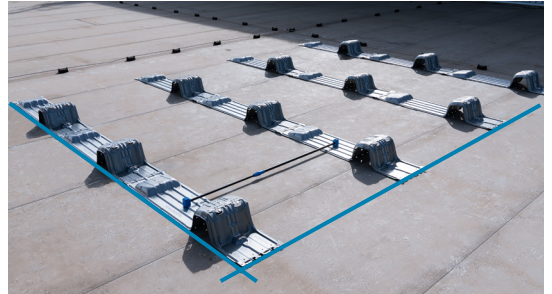

## STEP 2

### Ballasting iFIX sheets

Once the rows have the correct spacing, weigh down the iFIX Base sheets with ballast stones, not the iFIX S Connector. Please proceed exactly according to the complaint plan from the project report.

Note: Always place the ballast blocks starting at the high area.

Material: Ballast stones

Hint: When lightning current carrying connections are required, it is advisable to install them before PV modules are installed.





## STEP 3

### Install PV modules

Position the PV modules on the upper and lower positioning aids A and B, starting on the south side, and slide the upper frame to the stop C. Connect the cable and lay the PV module over the entire surface. A and B are positioning aids for the spacing of the PV modules.

Material: PV modules

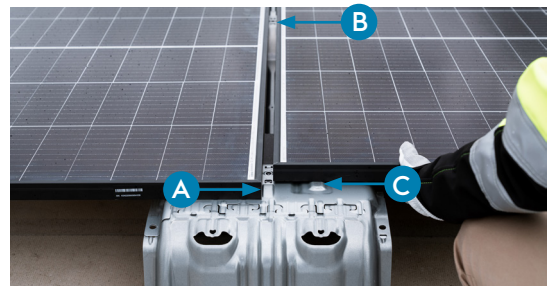

## STEP 4

### Cable connections

Plug the cable connections between the PV modules together and fasten them.

Material: Cable ties

Hint 1: The cables can be fixed to the C-shaped cut-outs in the sheet metal using cable ties.

Hint 2: Where supports for high snow loads (iFIX Alpin) are required, these should now be installed with the PV modules (see installation instructions for iFIX Alpin).



**STEP 5****Set clamps**

Tighten the clamps immediately after installing the PV modules with a tightening torque of 12 Nm. This involves the fine alignment of the iFIX sheet metal rows.

Material: PV modules, iFIX end clamps, iFIX centre clamps, cordless screwdriver, torque spanner with Allen bit: 8 mm

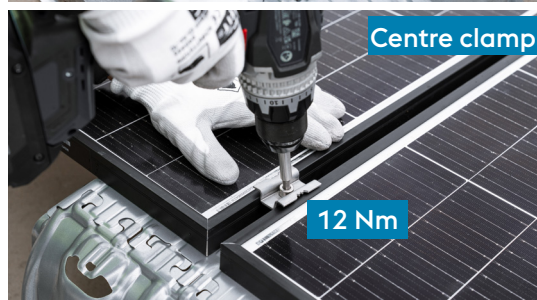
**STEP 6****iFIX S Deflector**

Slide one end of the iFIX S Deflector into the first upper fastening point (1), then into the lower one (2) and then into the upper one (3). Next, push the iFIX S Deflector through slightly and slide it into the three attachment points at the other end in the same order.

Insert the second iFIX S Deflector into the attachment points in the same order, overlapping the first one.

Material: iFIX S Deflector

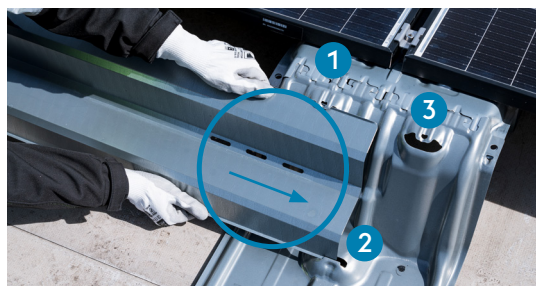



Move the iFIX S deflectors until they reach the end of the row, 40 to 60 mm from the edge of the iFIX S connector.

The iFIX S deflector overlap (X) results from the length of the PV modules and the selected length of the iFIX S deflector.

Hint: iFIX S Deflector 1780 for PV modules up to 1,780 mm in length.  
iFIX S Deflector 2100 for PV modules up to 2,100 mm in length.

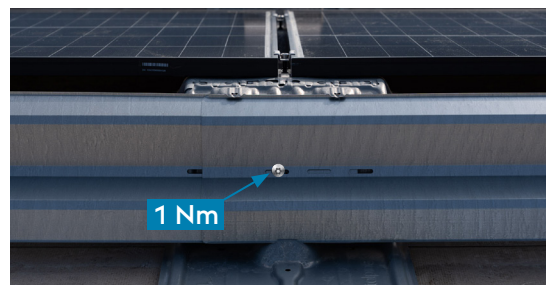
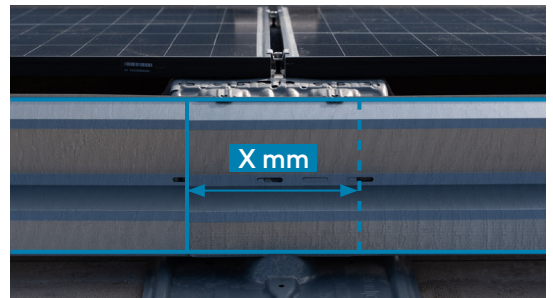
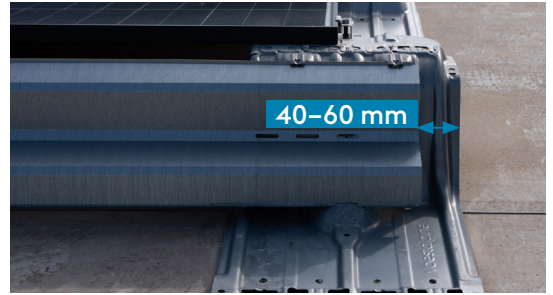

## STEP 7

### Potential equalisation/grounding

Tighten the iFIX S earthing connectors through the slotted hole into the hole of the iFIX S Connector with max. 1 Nm tightening torque

Material: iFIX grounding connector, cordless screwdriver, torque wrench with bit 

## STEP 8

### Ballasting the iFIX connector

Place the ballast on the iFIX S Connector according to the weighting plan from the project report.

## MAINTENANCE

The PV system must be inspected annually for mechanical safety. Check that the PV modules are firmly seated by lifting them by hand. Loose PV modules should be secured immediately. To maximise corrosion protection, accumulations of dirt should be removed, and coarse soiling removed with water. The PV module manufacturer's and installer's instructions are to be followed when servicing the PV modules and electrical cables.

## WARRANTY

The "General Terms and Conditions of Warranty for iFIX" and the "General Terms and Conditions of Sale" of voestalpine Automotive Components Schwäbisch Gmünd GmbH & Co. KG, available separately and valid at the time of purchase, shall apply

# ACCESSORIES

## Fastening the iFIX Base Protect

Place a building protection mat under each iFIX Base sheet. Raise the four tabs over the sheet at the marking on the edge of the sheet.

Material: iFIX Base Protect

Hint: Take note of the orientation of the mat: A round hole in the low area of the iFIX Base plate. The mat must not cover the water drainage holes.

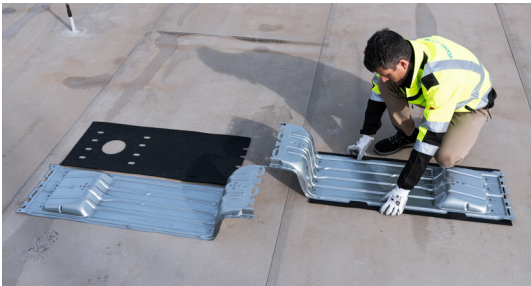
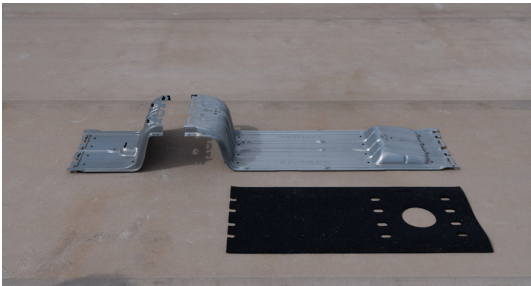

## Protector

Additional protective mat recommended for the last iFIX sheets in the assembly line

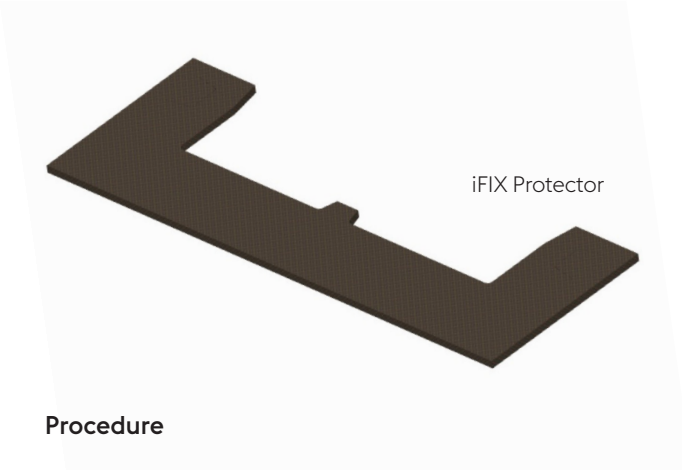

### Procedure

1. Always slide the protective mat under the iFIX plate on the unconnected side of the last iFIX plate.
2. Fold the tabs of the mat upwards over the sheet metal. Ensure that the mat is positioned in the area of the sheet metal rounding and that the mat completely underlays the click area.



## iFIX Spacer

Spacing gauge for simplified and correct alignment of the iFIX mounting plates

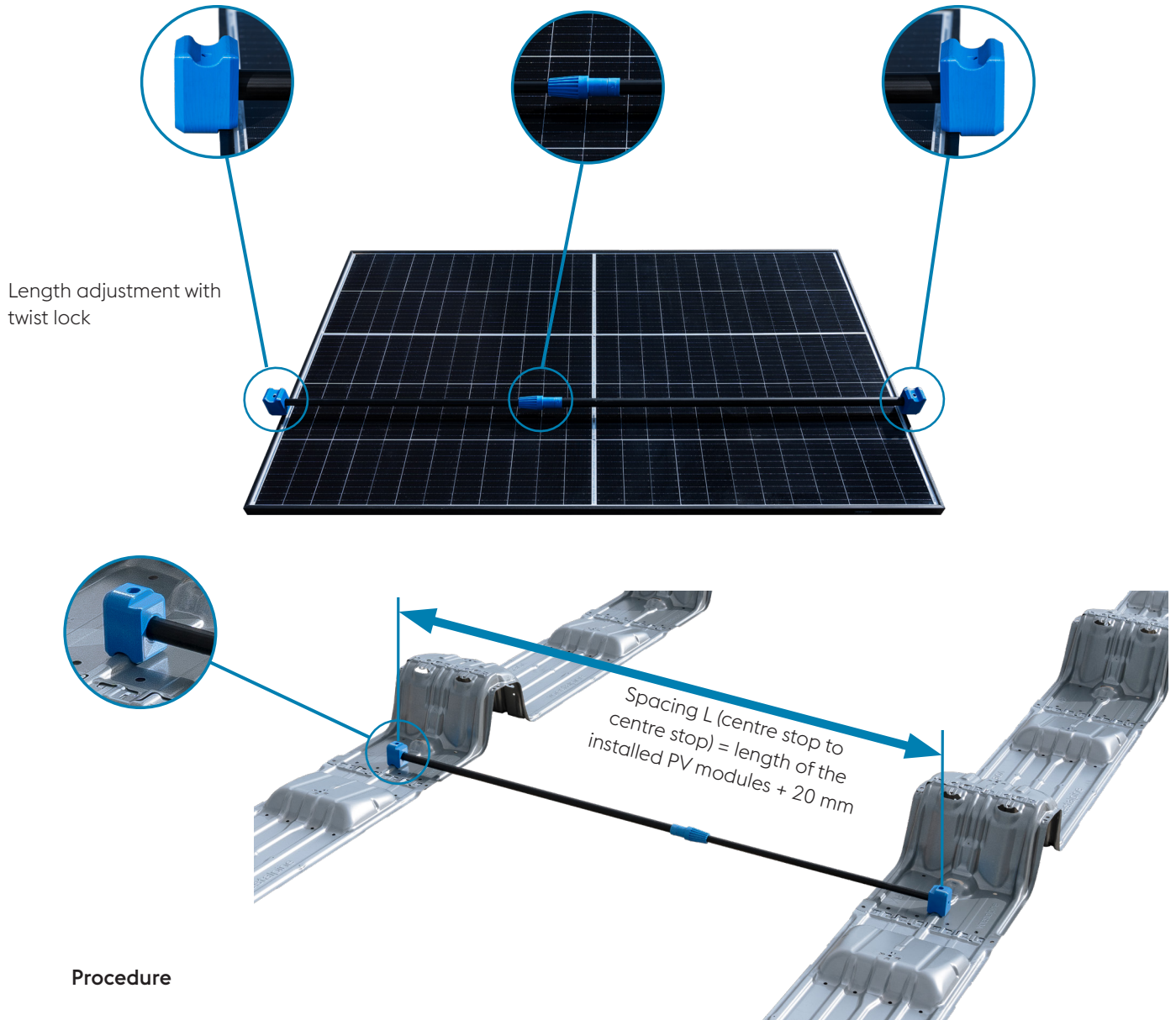

### Procedure

1. Adjust the spacer to the PV module length. Either use the stops on the blue moulded parts or follow the calculation. Release and lock the telescopic rod by turning the blue lock.
2. The two blue moulded parts of the spacer should always be positioned on the middle bead of the iFIX plate. Ensure the correct spacing at several positions on the iFIX rows.



# iFIX One Part – One Click



For your quick and easy source of information, click:  
[www.voestalpine.com/iFIX](http://www.voestalpine.com/iFIX)