

Busbar for ARROW S

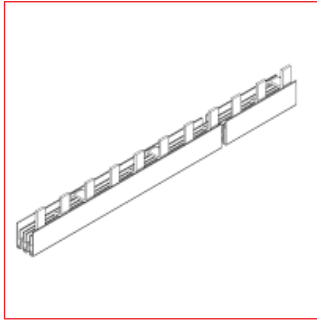

BS9001xx

Schrack-Info

- Pin busbars especially for D02-fuse-load-breaker series ARROW S
- Through the dual-function terminal it is possible to busbar and wiring in a terminal
- Pitch 27 mm
- 36 MW = 12 x 3-pole ARROW S

BS900147 Dimensions

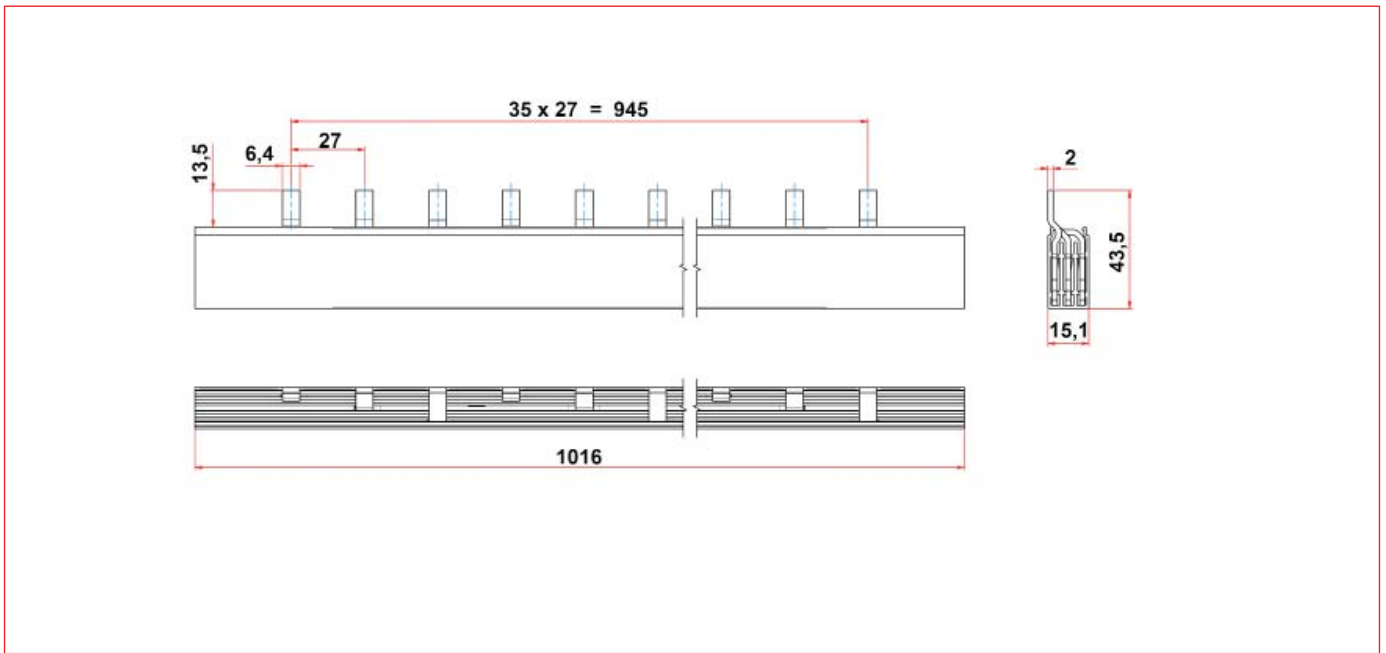

DESCRIPTION	AVAILABLE	ORDER NO.
ARROW S - Busbar 35mm ² , MW=27mm, 3-pole, 1m		BS900147
End-cap for ARROW S - Busbar BS900147		BS900189

DO-fuse switch-disconnector-socket TYTAN II up to 63A



IS504702-A

Schrack-Info

- Reliable with flashing indicator
- Plug-in style without screw cap
- Full coding through gauge-pieces for each current level
- For D0 fuse-links 2... 63 A
- Breaking capacity 50 kA
- Lockable, sealable, supply possible from both sides





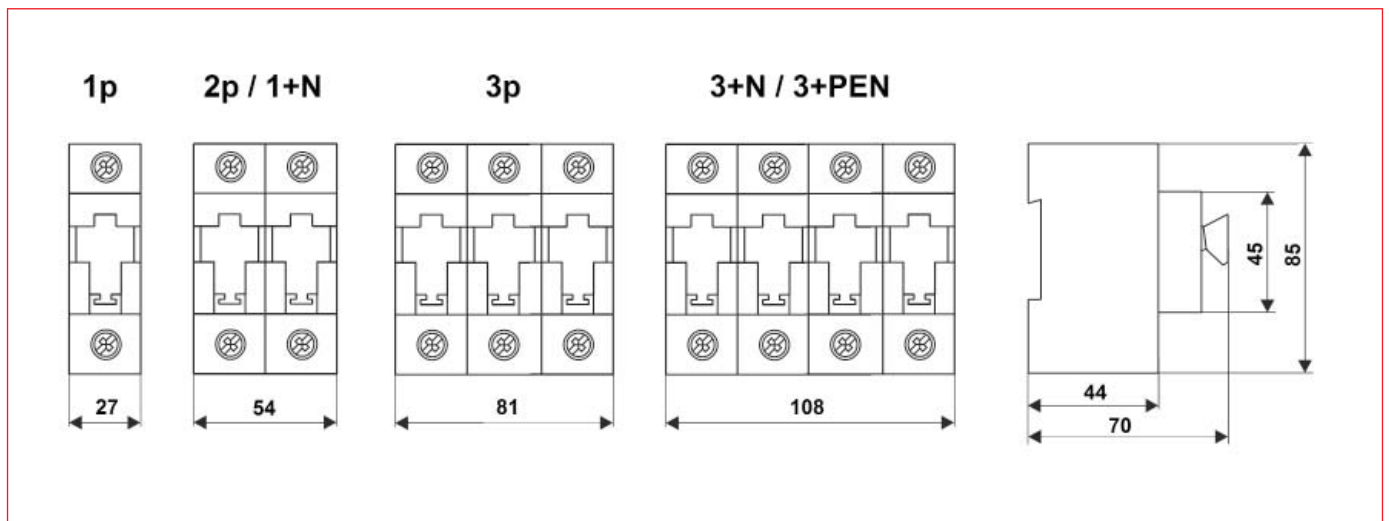



Classification	Fuse-switch-disconnector
Standards	EN 60947, IEC 60947-3 / DIN VDE 0636 part 41, DIN VDE 0660 part 107, IEC 60269-3 /DIN VDE 0638, DIN VDE 43880
Poles	3-pole
Handling	Plug-in technique without screw caps
Suitable for fuses	D02, 2-63A
Ambient air temperature Storage min/max	- 25°C/ + 100°C
Operation min/max	- 25°C/ + 60°C
Insulating parts synthetic	material free of halogen, phosphorus and silicone
Fire class / creep resistance	UL94/V0, heat filament test 960°C/CTI 600
Protection / contact-voltage protection	IP 20/finger and backhand protection
Rated operation voltage U_e	400 V-AC
Rated operation current I_n	63 A
Rated constant current I_U	63 A
Overvoltage category / Pollution degree	IV/3 (DIN VDE 0110)
Rated surge capacity U_{imp}	6000 V
Rated special voltage	400 V-AC
Rated short circuit making capacity I_{CM}	50kAeff
Switching category AC 22B	AC 22B
Connection technique	Stainless steel terminal cage without galvanic surface
Terminal - Branch terminal suitable for	a) 1 solid conductor, fine or multiple wires 1,5mm ² - 35mm ² b) above: terminal lugs of wiring bars under: fine wires with wire end ferrule 6 mm ² c) 2 solid conductor fine wires with wire end ferrule from each 2 x 1,5 mm ² - each 2 x 16 mm ²
Torque MD M6 Pozidriv	4Nm
Lockable	by customary padlock
Sealable	yes
Feed in both sides	in both sides

Dimensions



D0-fuse material series SCHRACK

D0-fuse switch-disconnector-socket TYTAN II up to 63A

DESCRIPTION	AVAILABLE	ORDER NO.
1-pole		IS504700-A
2-pole		IS504701-A
3-pole		IS504702-A
3-pole, fixed adjust, 25 A		IS509325
3-pole, fixed adjust, 35 A		IS509335
3-pole, fixed adjust, 50 A		IS509350
1-pole + N		IS504703-A
3-pole + N		IS504704-A
3-pole with PEN-terminal		IS504730

■ Fuse plug for TYTAN II



IS504716-A

■ Schrack-Info

- Plug-in principle, without screw cap, with touch-proof gauge-pieces, D0 fuse, complete (1 set = 3 pieces) in mounting box
- With flashing indicator
- Rated voltage 400 V AC
- Characteristic gG/gL

DESCRIPTION	AVAILABLE	ORDER NO.
2A, pink, D01		IS504710-A
4A, brown, D01		IS504711-A
6A, green, D01		IS504712-A
10A, red, D01		IS504713-A
16A, grey, D01		IS504714-A
20A, blue, D02		IS504715-A
25A, yellow, D02		IS504716-A
32A, purple, D02		IS504726
35A, black, D02		IS504717-A
40A, violet, D02		IS504740
50A, white, D02		IS504718-A
63A, copper, D02		IS504719-A

■ D0-fuse switch-disconnector TYTAN II complete up to 63A



IS5047PL25

■ Schrack-Info

- Plug-in style without screw cap
- Coding through gauge-pieces for the current level

DESCRIPTION	AVAILABLE	ORDER NO.
TYTAN II 3-pole, complete 20A, with flashing indicator		IS5047PL20
TYTAN II 3-pole, complete 25A, without flashing indicator		IS5047PL25
TYTAN II 3-pole, complete 35A, without flashing indicator		IS5047PL35
TYTAN II 1-pole, fixed adjust, complete, 40 A, with flashing indicator		IS509340
TYTAN II 3-pole, complete 50A, without flashing indicator		IS5047PL50
TYTAN II 3-pole, complete 63A, without flashing indicator		IS5047PL63
TYTAN II 1-pole, fixed adjust, complete, 25 A, with flashing indicator		IS504729



Order no. blue: on stock, usually ready for delivery on the day of order

Accessories for TYTAN II

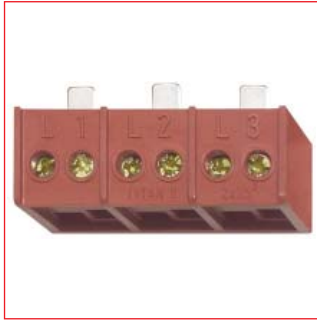

IS504722



IS504721

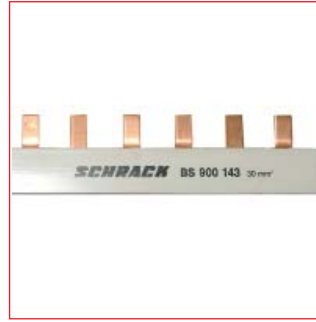

BS900143

Schrack-Info

- Connection bridges
- Connection terminals
- 3- and 4-pole busbars



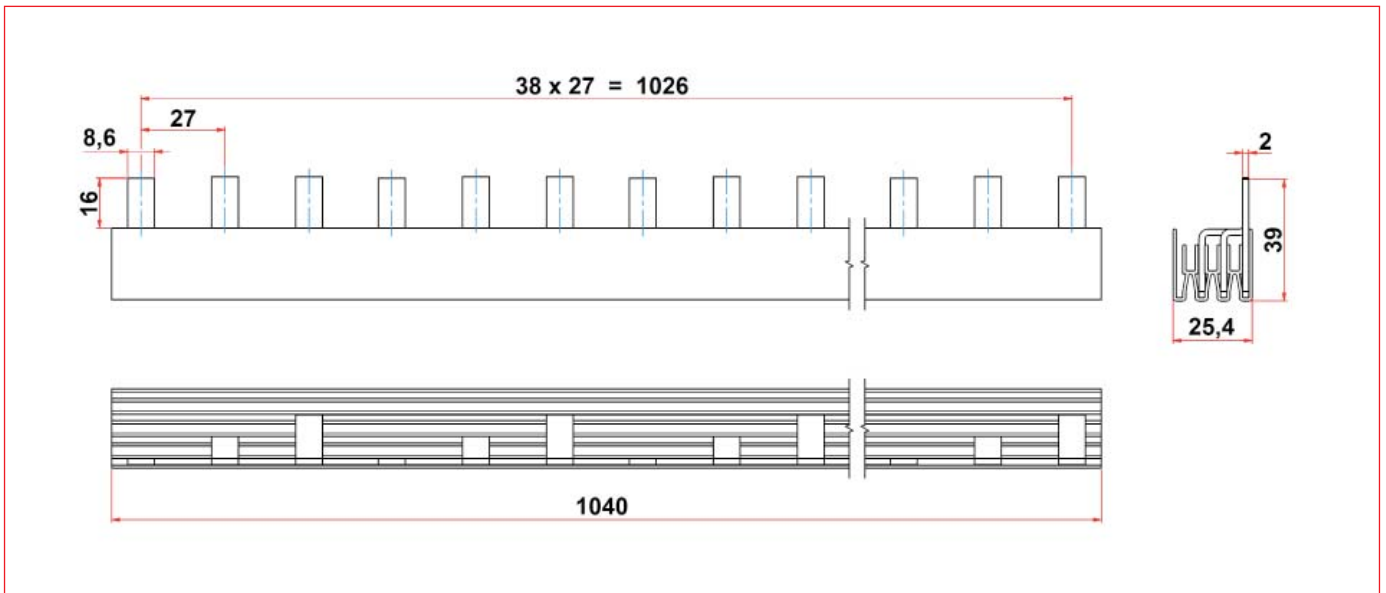



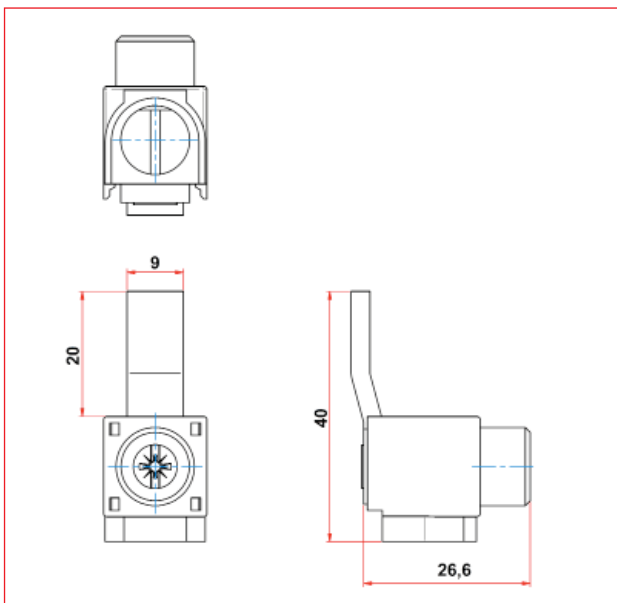



BS900143 Dimensions



BS900179 Dimensions



Accessories for TYTAN II

DESCRIPTION	AVAILABLE	ORDER NO.
Connection bridge for TYTAN II		IS504725
Empty box TYTAN 2300		IS504741
Locking part with plastic lock for TYTAN II		IS504721
Double terminal 3 x 2 x 35mm for TYTAN II and Coron		IS504722
TYTAN II - terminal 95mm ²		IS504724
Connection Terminal 50mm ² , Pin 20x9mm Straight		BS900179
Busbar Pin Version 1 pole, 16mm ² / MW=27mm for Neozed, 1 m		BS900133
Busbar Pin Version 3 pole, 16mm ² / MW=27mm for Neozed, 1 m		BS900134
Busbar end-cap 2/3-pole		BS900116
TYTAN Busbar Pin Version 30mm ² / MW=27mm, 3 pole, 1 m		BS900143
TYTAN Busbar Pin Version 30mm ² / MW=27mm, 4 pole, 1 m		BS900144
Busbar End Cap 3/4P 30mm ² , for BS900143 and BS900144		BS900187

