

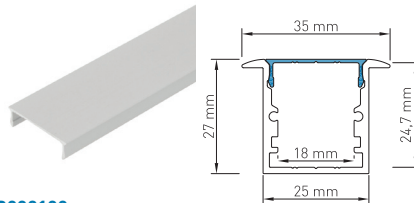

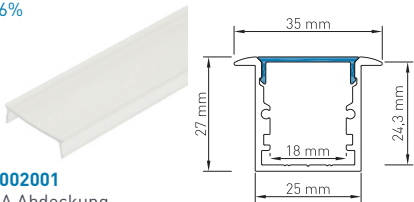

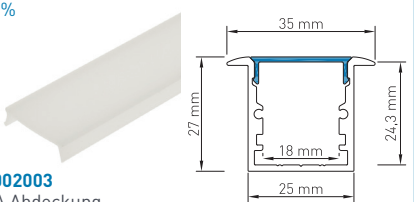
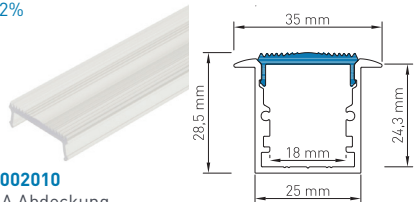
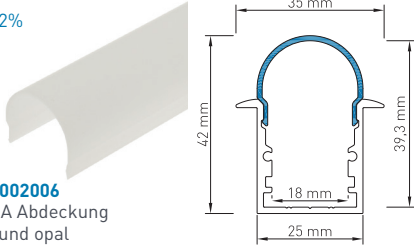
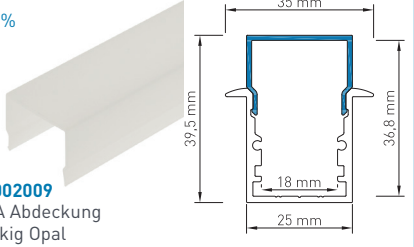
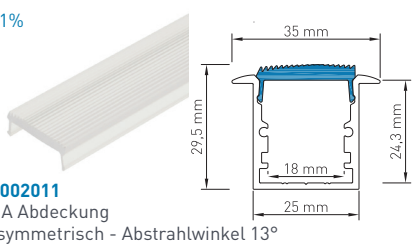

ALUMINIUM PROFILE & ABDECKUNGEN   ALUMINIUM PROFILES & COVERS	
 <p><b>LIAP002003</b> Aluminium Profil TBI Aluminium profile TBI</p>	 <p><b>LIAB002100</b> Aluminium Abdeckung TB Aluminium cover TB</p>

PROFIL ABDECKUNGEN UND EINSCHÜBE   PROFILE COVERS AND INSETS		
<p><math>\eta \approx 56\%</math></p>  <p><b>LIAB002001</b> PMMA Abdeckung TB Flach Transparent PMMA cover TB flat transparent</p>	<p><math>\eta \approx 37\%</math></p>  <p><b>LIAB002003</b> PMMA Abdeckung TB Flach Opal PMMA cover TB flat milky</p>	<p><math>\eta \approx 52\%</math></p>  <p><b>LIAB002010</b> PMMA Abdeckung TB engstrahlend - Abstrahlwinkel 10° PMMA cover TB narrow beam - beam angle 10°</p>
<p><math>\eta \approx 42\%</math></p>  <p><b>LIAB002006</b> PMMA Abdeckung TB Rund opal PMMA cover TB round milky</p>	<p><math>\eta \approx 46\%</math></p>  <p><b>LIAB002009</b> PMMA Abdeckung TB Eckig Opal PMMA cover TB square milky</p>	<p><math>\eta \approx 51\%</math></p>  <p><b>LIAB002011</b> PMMA Abdeckung TB asymmetrisch - Abstrahlwinkel 13° PMMA cover TB asymmetrical - beam angle 13°</p>

PROFIL ENDKAPPEN   PROFILE ENDCAPS		
<p>Endkappenstärke   End cap thickness 2,5mm</p>  <p><b>LIEK002300</b> Profil Endkappe TBI Flach geschlossen Profile endcap TBI flat closed</p>	<p>Endkappenstärke   End cap thickness 2,5mm</p>  <p><b>LIEK002310</b> Profil Endkappe TBI Rund geschlossen Profile endcap TBI round closed</p>	<p>Endkappenstärke   End cap thickness 2,5mm</p>  <p><b>LIEK002320</b> Profil Endkappe TBI Eckig geschlossen Profile endcap TBI square closed</p>
<p>Endkappenstärke   End cap thickness 2,5mm</p>  <p><b>LIEK002301</b> Profil Endkappe TBI Flach mit Langloch Profile endcap TBI flat with cable entry</p>	<p>Endkappenstärke   End cap thickness 2,5mm</p>  <p><b>LIEK002311</b> Profil Endkappe TBI Rund mit Langloch Profile endcap TBI round with cable entry</p>	<p>Endkappenstärke   End cap thickness 2,5mm</p>  <p><b>LIEK002321</b> Profil Endkappe TBI Eckig mit Langloch Profile endcap TBI square with cable entry</p>

- 1m
- 2m
- 4m
- SONDER LÄNGE
- SPECIAL LENGTH

STANDARDLÄNGE = 2M | ALLE ANDEREN LÄNGEN SIND VOM UMTAUSCH UND DER RÜCKGABE AUSGESCHLOSSEN. LÄNGEN ÜBER 2M WERDEN MITTELS SPEDITION VERSENDET UND ERFORDERN EINE MINDESTBESTELLMENGE VON 10 STK.

STANDARD LENGTH = 2M | ALL OTHER LENGTHS ARE EXCLUDED FROM EXCHANGE AND RETURN. LENGTHS OVER 2M ARE SHIPPED BY FREIGHT CARRIER AND REQUIRE A MINIMUM ORDER QUANTITY OF 10 PCS.

**HINWEIS**  
PLEASE NOTE

Kunststoff und Aluminium besitzen unterschiedliche Ausdehnungskoeffizienten, welche bei der Montage zu berücksichtigen sind. Ausgehend von 20°C verändert sich die Länge beim Aluminium um ca. 0,25mm pro Meter und beim Kunststoff um ca. 0,70mm pro Meter je 10°C Temperaturunterschied.

Plastic and aluminium have different expansion coefficients, which must be considered during assembly. Based on 20°C the length of aluminium changes approximately 0,25mm per meter and plastic approximately 0,70 mm per meter per 10°C of difference in temperature.