

**ALUMERO**

**AS 2.1**  
**TILED ROOFS**

**EN**

**SOLAR INSTALLATION INSTRUCTIONS**

Before installation, please read the safety instructions at the end of this installation manual very carefully – and make sure you are using the latest edition of these instructions.

Layout and planning of this installation system should be conducted using the ALUMERO Solar.Pro.Tool software. Please ensure you have all the requisite materials, positioning and layouts for each individual component according to the project report provided with Solar.Pro.Tool, and/or by your ALUMERO sales partner. The data have all been calculated within statutory static tolerance levels and are of great importance to the safe and smooth operation of the system.

Prior to commencement, technicians responsible for installing the photovoltaic system must ensure the existing roof construction is capable of bearing the additional loads and forces. We suggest contacting a local statics specialist.

This installation instruction manual explains installation procedures for ALUMERO tiled roof components, attachment to the substructure for the roof, and assembly of the modules.

Modules are usually mounted vertically to tiled roofs with the truss profiles parallel to the roof ridge. Two truss profiles per module row are used as standard.

The ALUMERO tiled roof system is intended solely to carry PV modules. Any other applications of the system shall be considered examples of misuse.

**The use of extra-tilt fixtures is not recommended for tiled roofs.**

Mounting must only be conducted by trained personnel. Roofing tasks in particular should only be carried out by professional roof contractors.

If you have any other questions, please take advantage of our comprehensive professional advisory service provided by ALUMERO's expert construction engineers.

# LIST OF CONTENTS

|   |         |
|---|---------|
| General information.....  | P 3     |
| Components.....   | P 4-5   |
| How to attach roof hooks.....                                       | P 6-9   |
| How to attach beaver tail tile roof hooks.....                      | P 10    |
| How to attach slate tile roof hooks.....                            | P 11    |
| How to mount truss profiles in a single direction.....              | P 12-13 |
| How to mount truss profiles in a lattice arrangement.....           | P 14-16 |
| How to mount modules.....   | P 17    |
| How to attach AL13 X roof hooks.....                                | P 18-20 |
| How to mount modules.....   | P 21    |
| How to attach module cables   Equipotential bonding   Earthing..... | P 22-23 |
| Key points.....   | P 24-28 |

## GENERAL INFORMATION

|                                |  |             |
|--------------------------------|--|-------------|
| <b>Use:</b>                    | Tiled roofs, beaver tail tiled roofs, slate tile roofs |             |
| <b>Roof gradients:</b>         | 10° - 65°  |             |
| <b>Means of attachment:</b>    | Plate head screws                                      |             |
| <b>Module arrangement:</b>     | Vertical / horizontal                                  |             |
| <b>Max. module field size:</b> | 12m (length)   |             |
| <b>Screw mounting:</b>         | MA (A2-70)   | M10 (A2-70) |
| <b>Torque:</b>                 | 15 Nm  | 30 Nm       |

## TOOLS REQUIRED

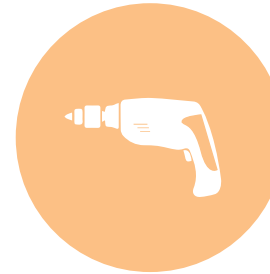

**Battery-powered drill**  
with the following bits:  
Hex bit **SW 6**

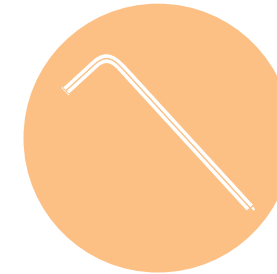

**Hex key SW6**

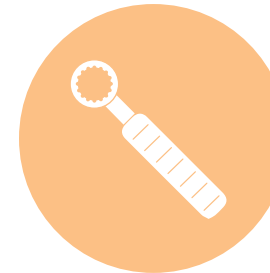

**Torque wrench**

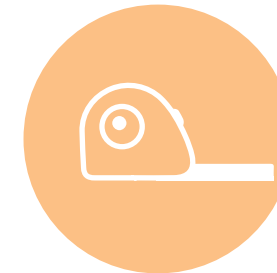

**Measuring tape**

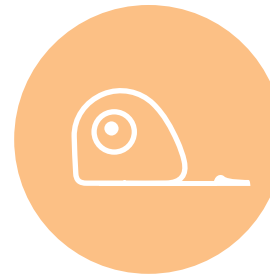

**Chalk line tool**

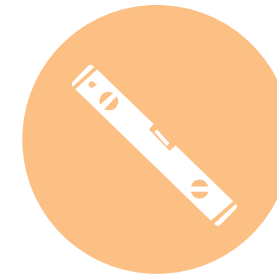

**Spirit level**

# COMPONENTS

## STANDARD



**Roof hooks AL13/ALS13**  
Product number:  
80241x

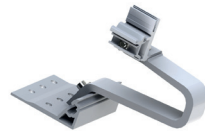

**Roof hooks AL13 X**  
Product number:  
802414



**Rapid-mount 40 x 10  
roof hook**  
Product number:  
802406



**Truss profile**  
Product number:  
80210x



**Profile connector**  
Product number:  
80215x



**Plate head screw**  
Product number:  
8006x

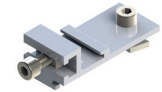

**Cross-connector 2.1**  
Product number:  
802200



**Preassembled closing  
clamp with a pin**  
Product number:  
802304-xxV P1



**Preassembled  
closing clamp**  
Product number:  
802304-xxV



**Click end clamp  
with a pin**  
Product number:  
802304CP



**Click end clamp  
without a pin**  
Product number:  
802304C



**Click middle clamp  
with a pin**  
Product number:  
802301C P1 30-45



**Click middle clamp  
without a pin**  
Product number:  
802301C 30-45

# COMPONENTS

---

## OPTIONAL



**Rapid-mount  
beaver tail roof  
hook**

Product number:  
802425



**Beaver tail sheet  
metal tile AS 2.1**

Product number:  
802620



**Rapid-mount slate  
tile roof hook**

Product number:  
802423



**Brick replacement  
board AS 2.1  
Universal 350**

Product number:  
Red - 802625  
Black - 802626



**Brick replacement  
board AS 2.1  
Universal 420**

Product number:  
Red - 802627  
Black - 802628



**Rapid-mount Tegalit  
roof hook**

Product number:  
802422

---

## ACCESSORIES



**Cable tie with a clip**

Product number:  
802604



**Wire clamp**

Product number:  
802603



**Aluminium wire**

Product number:  
802602



**Underlay plate**

Product number:  
80260x



**End cap**

Product number:  
802601

## MOUNTING WITH ROOF HOOKS

### VERTICAL MODULE ARRANGEMENT - SINGLE DIRECTION

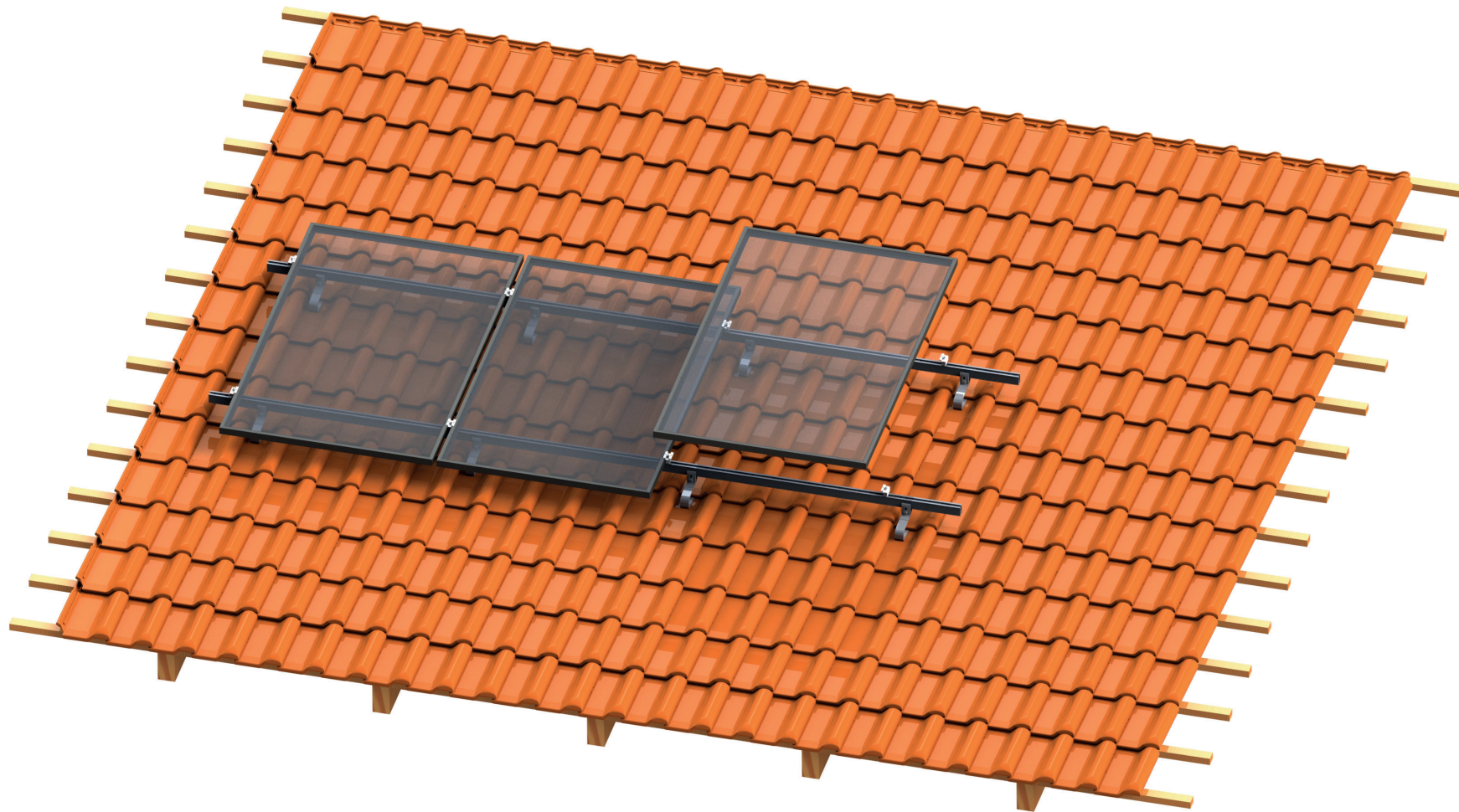

# MOUNTING ROOF HOOKS

1

## MEASURE AND MARK POSITIONS

Measure, position and mark the locations for the roof hooks on the roof according to the [Solar.Pro.Tool project report](#).

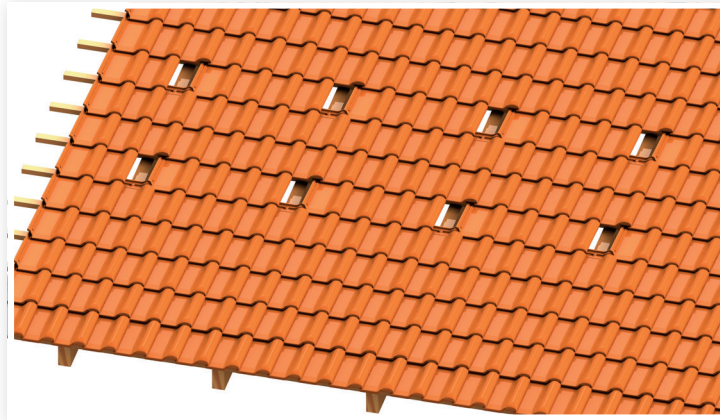

Ensure you use the **module clamping area** provided in the installation instructions for the module in use.

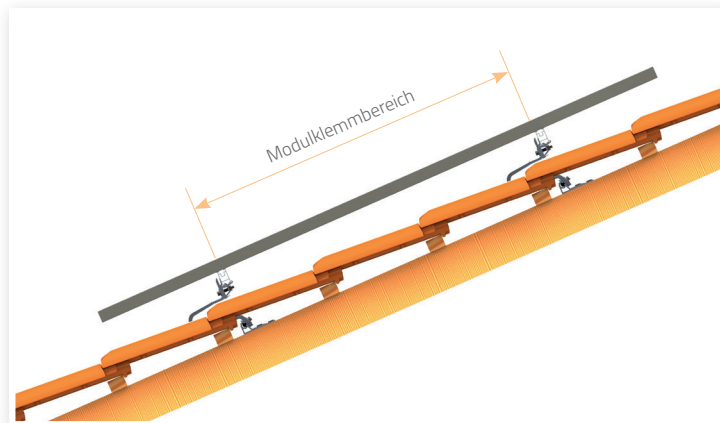

2

## MOUNTING THE ROOF HOOKS

Remove the marked roof tile above the rafter.

Position the roof hook so that it protrudes over the trough of the tile below.

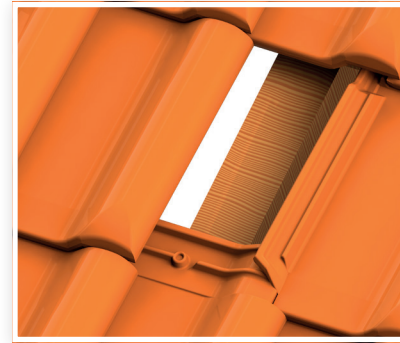

The curve of the hook must **not touch the tile below**. Ensure a **gap of at least 3-5mm**.

Horizontally there must also be a **gap of 3-5mm** to the next tile.

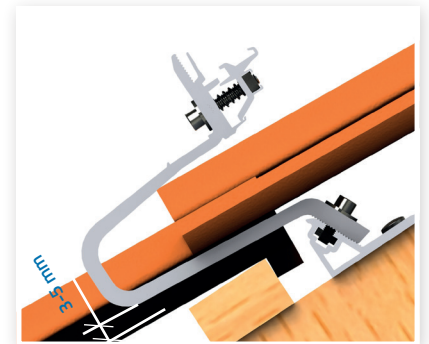
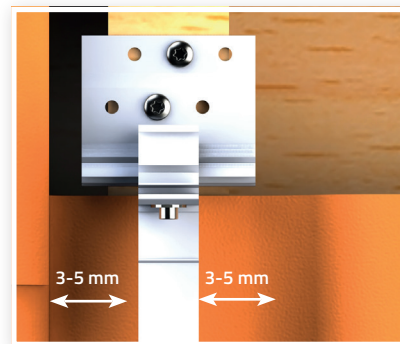

## MOUNTING THE ROOF HOOKS

If necessary, remove a section of the lip of the next tile **down** using an angle grinder (diamond blade).



Optionally, the tile below the roof hook can be replaced with a sheet metal tile. Remove the lip of the tile **above** with an angle grinder (diamond blade).



Use a string to find the right position for the hook along the horizontal plane and attach it with two **2 plate head screws** driven into the rafter. Make sure there is a screw in every row of holes.

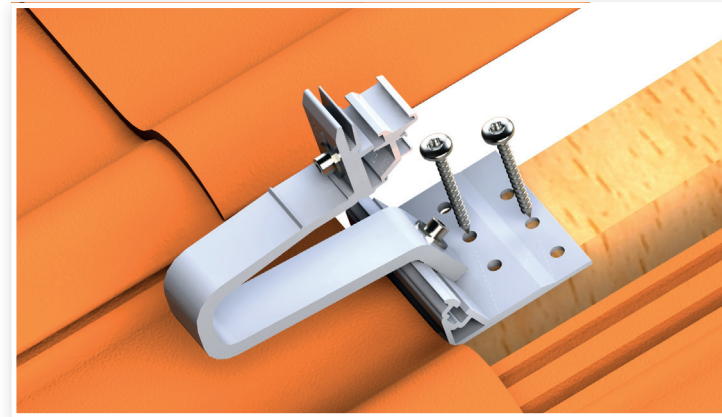

### Please note:

- The **AL13 roof hook** can be adjusted in **3 directions** to ensure the required minimum gaps can be adhered to easily. Tighten the fixing screws to a torque of **15Nm**.
- Holes of approx. **0.7 x screw diameter** must be **pre-drilled** in the wooden substructure..
- Ensure you only cut away part of the lip of the tile and do not cut into the tile.
- When mounting the sheet metal tile, make sure you use the manufacturer's installation instructions.



**Please note:** Once mounted, roof hooks must not be used as footholds!



## MOUNTING THE ROOF HOOKS

Ensure the **ground plate** of the hook is fully connected to the rafter. Uneven areas can be compensated for with a variety of extra underlay plates.

Use additional rafters or purlins to ensure the **ground plate** of the roof hook is in full contact.

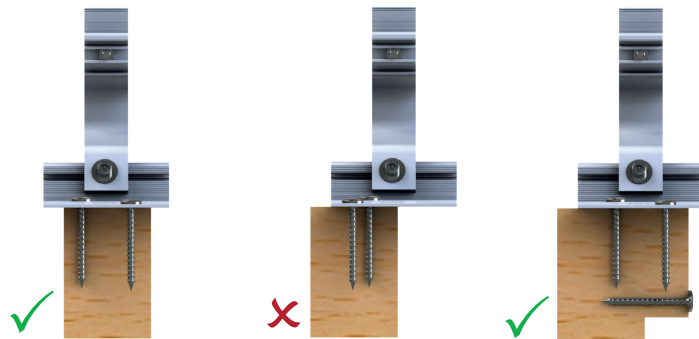

Replace the previously-removed roof tile correctly. If required, remove part of the lip of the tile an angle grinder. Make sure the roof remains

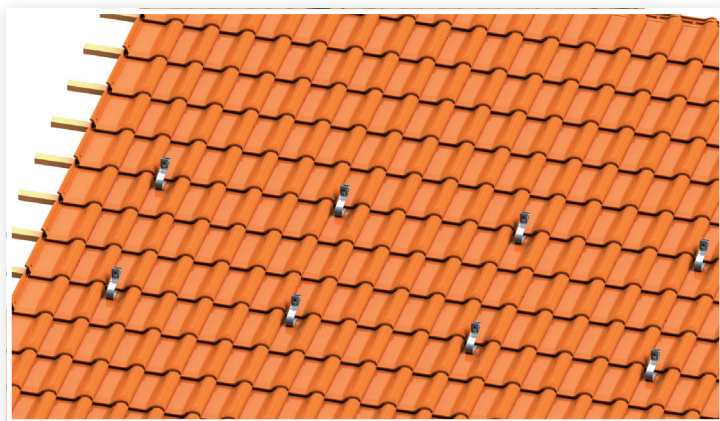

Where there is insulation between the rafters and the tiles, it is necessary to use 2 '**wood screws with fixing threads**' to attach the hooks to the rafters. The wood screws must be anchored at **least 60mm** into the rafters.

The wood screws with a fixing thread must be provided at the site.

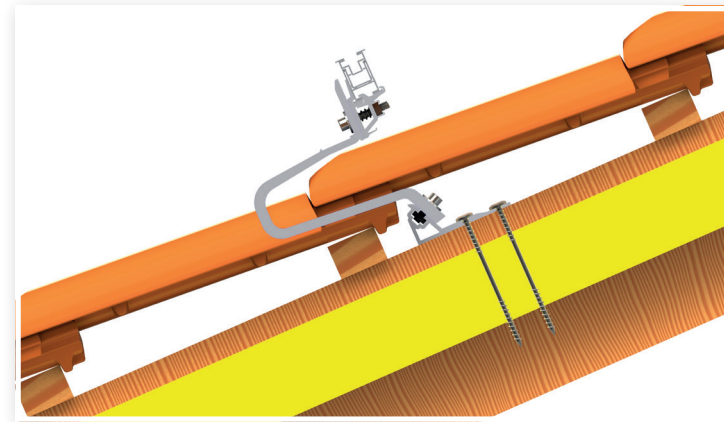

### Please note:

- The **gap between the edge** of the plate head screw and the end of the rafter must be at **least 24mm**.
- The plate head screw must be inserted to a **depth of at least 60mm**.
- Ideally recommended for roofs with rafters at least 80mm across, and at **least 60mm**.
- It is necessary to pre-drill holes into the wooden substructure when using wood screws.
- We recommend that roofing tasks should only be carried out by professional roof contractors.

# MOUNTING BEAVER TAIL ROOF HOOKS

1

## MEASURE AND MARK POSITIONS

Measure and mark the positions of the roof hooks on the roof using the **Solar.Pro.Tool project report** and remove the roof tiles above the rafter.

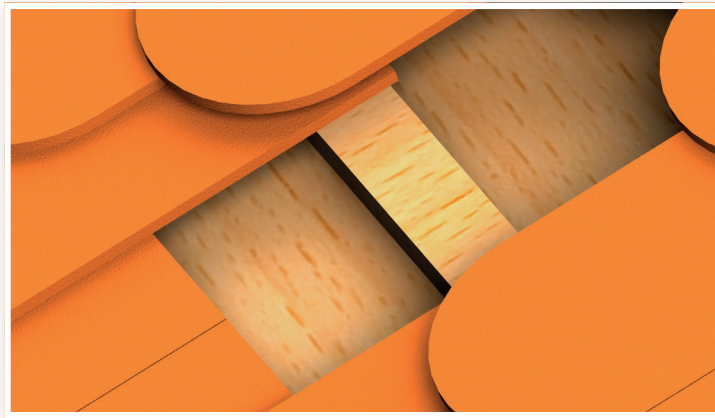

Modules must only be clamped in the **sections prescribed for attachment**. These can be found by consulting the manufacturer's respective module data sheet.

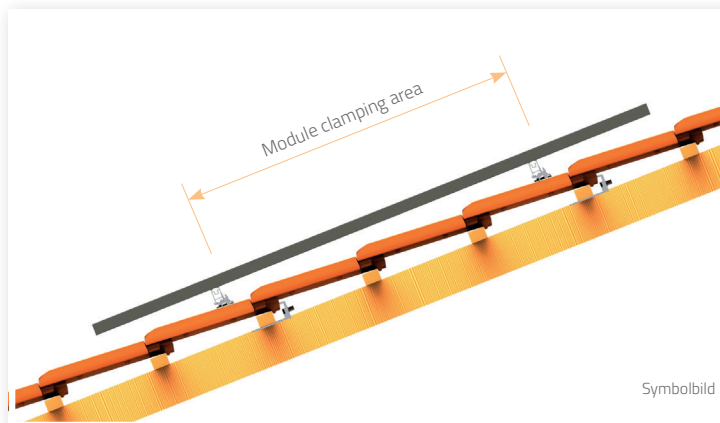

2

## MOUNTING BEAVER TAIL ROOF HOOKS

The tile below the roof hook should be replaced with a sheet metal tile. Attach the hook with **2 plate head screws** driven into the rafter.

Replace the previously-removed roof tile correctly. Make sure the roof remains entirely watertight.

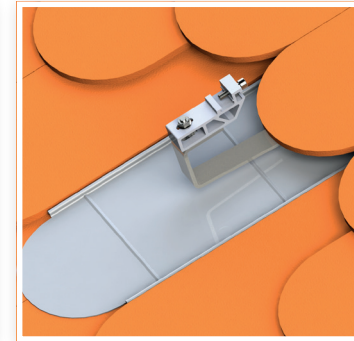
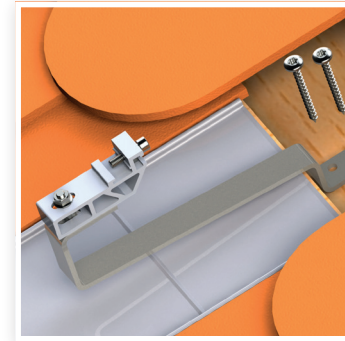

### Please note:

- The **gap between the edge** of the plate head screw and the end of the rafter must be at **least 24mm**.
- The plate head screw must be inserted to a **depth of at least 60mm**.
- Ideally recommended for roofs with **rafters at least 80mm** across, and at least 60mm
- It is necessary to pre-drill holes into the wooden substructure when using wood screws.
- We recommend that roofing tasks should only be carried out by professional roof contractors.

# MOUNTING SLATE TILE ROOF HOOKS

1

## MEASURE AND MARK POSITIONS

Measure and mark the positions of the roof hooks on the roof using the **Solar.Pro.Tool project report** and remove the roof tiles over each rafter.

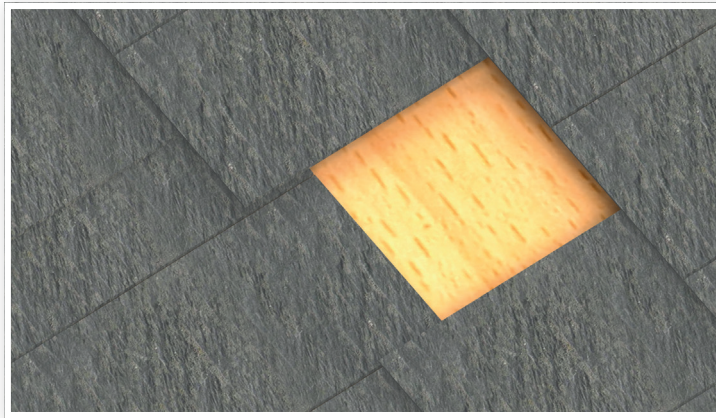

Modules must only be clamped in the **sections prescribed for attachment**. These can be found by consulting the manufacturer's respective module data sheet.

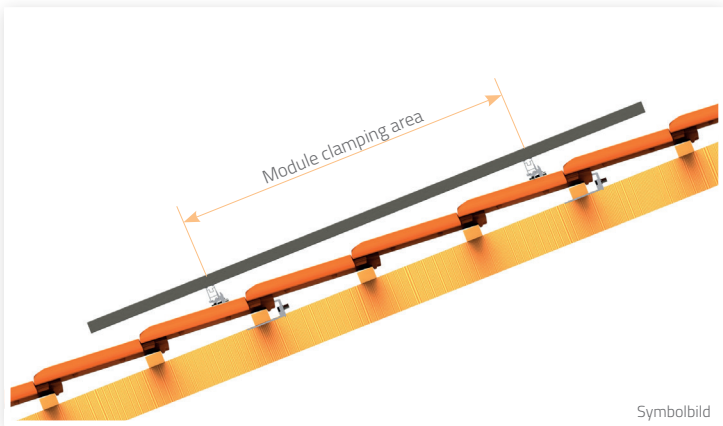

2

## MOUNTING SLATE TILE ROOF HOOKS

If necessary, remove the slates where drilling is required and replace them with the specially-designed titanium-zinc sheet slates to guarantee the surrounding slates remain watertight. Attach the hook with **2 plate head screws** driven into the rafter.

Reinstall all roofing correctly and ensure you comply with the directives of the German Roofers' Guild.

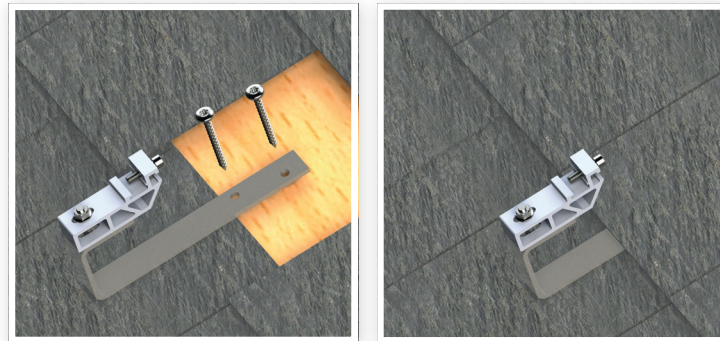

!

### Please note:

- The **gap between the edge** of the plate head screw and the end of the rafter must be at least **24mm**.
- The plate head screw must be inserted to a **depth of at least 60mm**.
- Ideally recommended for roofs with rafters at **least 80mm across**, and at least 60mm.
- It is necessary to pre-drill holes into the wooden substructure when using wood screws.
- We recommend that roofing tasks should only be carried out by professional roof contractors

# MOUNTING OF THE TEGALIT ROOF HOOKS

1

## MEASURE AND MARK POSITIONS

Measure and mark the positions of the roof hooks on the roof using the [Solar.Pro.Tool project report](#) and remove the roof tiles over each rafter.

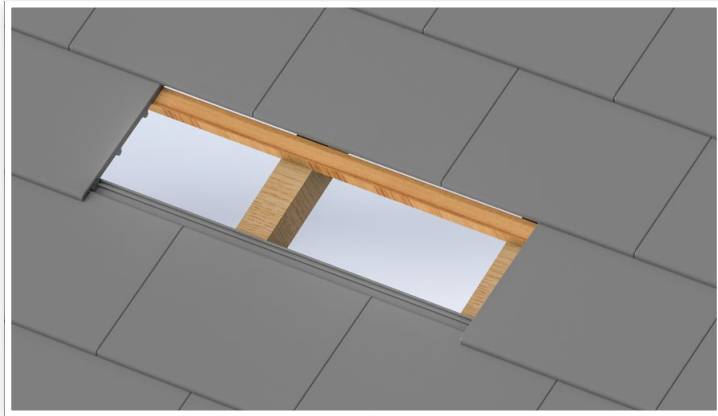

Modules must only be clamped in the **sections prescribed for attachment**. These can be found by consulting the manufacturer's respective module data sheet.

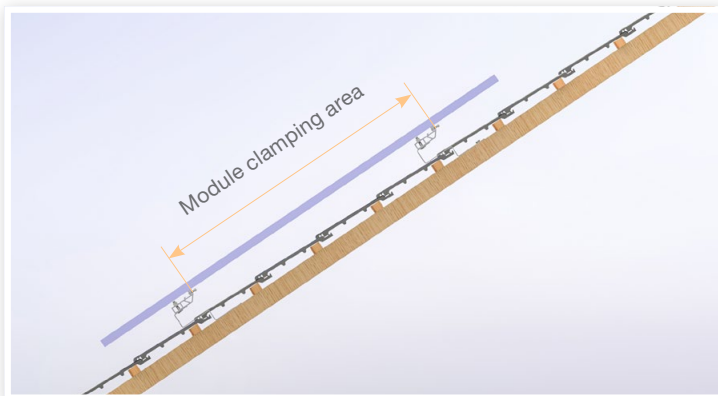

2

## MOUNTING OF THE TEGALIT ROOF HOOKS

Screw in the roof hook into the rafter with **2 plate head screws**.

Reinstall all roofing correctly and ensure you comply with the directives of theG German Roofers' Guild..

Optionally, the brick replacement board can be used for mounting.

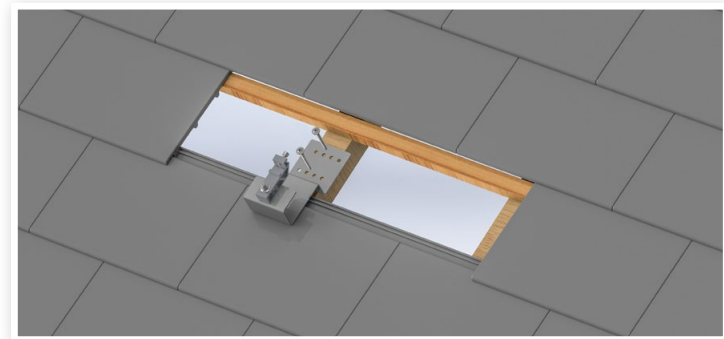

### Please note:

- The **gap between the edge** of the plate head screw and the end of the rafter must be at least **24 mm**.
- The plate head screw must be inserted to a **depth of at least 60mm**.
- Ideally recommended for rooftops with rafters at **least 80mm across**, and at least 60mm
- It is necessary to pre-drill holes into the wooden substructure when using wood screws.
- We recommend that roofing tasks should only be carried out by professional roof contractors

# MOUNTING THE TRUSS PROFILE - SINGLE DIRECTION

1

## MOUNT TRUSS PROFILE

Mount the truss profile onto the roof hooks, parallel to the ridge of the roof, with the correct side up, and tighten to a torque of **15 Nm**.



!

### Please note:

- Every truss profile must be attached in at least two places!
- Truss profile end contact surfaces must not be situated at points of attachment.

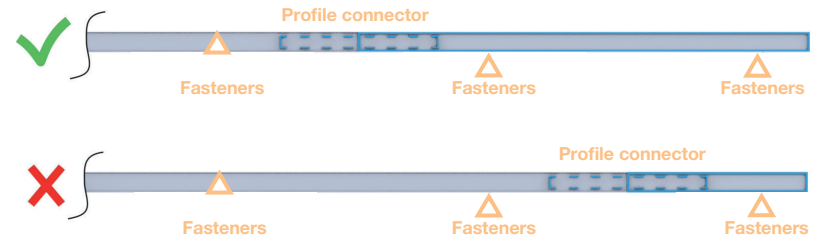

- Truss profile length: **max. 12m!**
- Ensure an expansion joint of at least **5cm** is included at a maximum of every **12m!**
- Extensions of the truss profiles beyond the final point of attachment according to sketch!

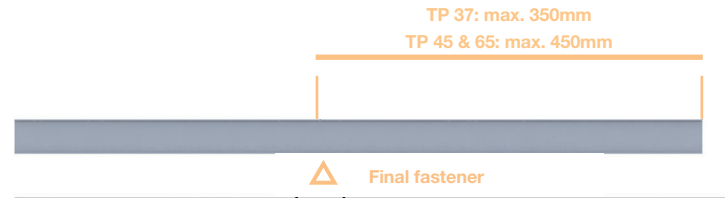

- Measure the correct positions for the profile connectors according to the **Solar.Pro.Tool project report** and optionally **screw down** the profile connector.



2

## CONNECT THE TRUSS PROFILES

Necessary when the width of the module field is greater than the length of the truss profile.

Push the profile connector halfway into the first truss profile, then connect the second truss profile to the profile connector.



3

### FITTING THE END CAPS

Press the end caps into the open ends of the profiles.

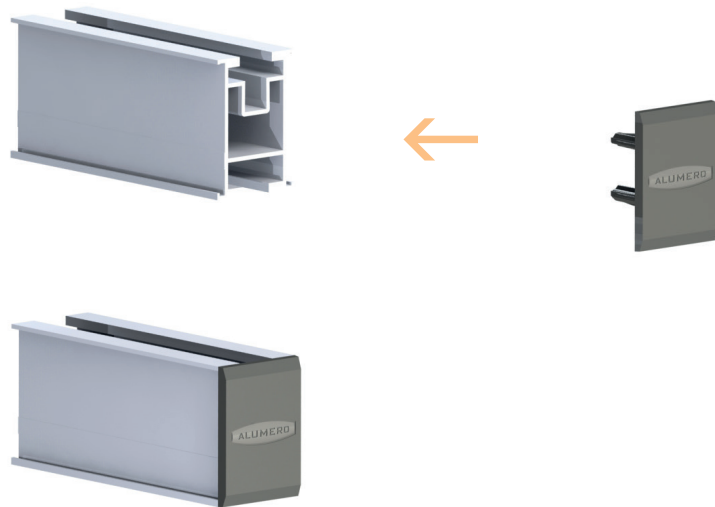

!

### ALTERNATIVES FOR ATTACHING TRUSS PROFILES TO ROOF HOOKS

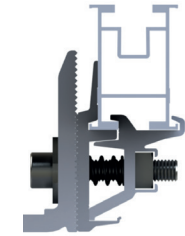

Attachment with the rapid-mount adapter  
– height-adjustable

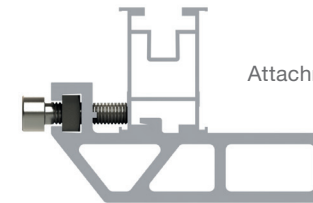

Attachment with the rapid-mount adapter

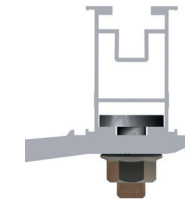

Attachment with the T-head anchor bolt  
and hex nut



**Please note:** Ensure truss profiles are mounted straight and without tension. Tightening torque for fixing screws:  
**M8 15 Nm / M10 30 Nm.**

## MOUNTING TRUSS PROFILES IN A LATTICE ARRANGEMENT HORIZONTAL MODULE ARRANGEMENT

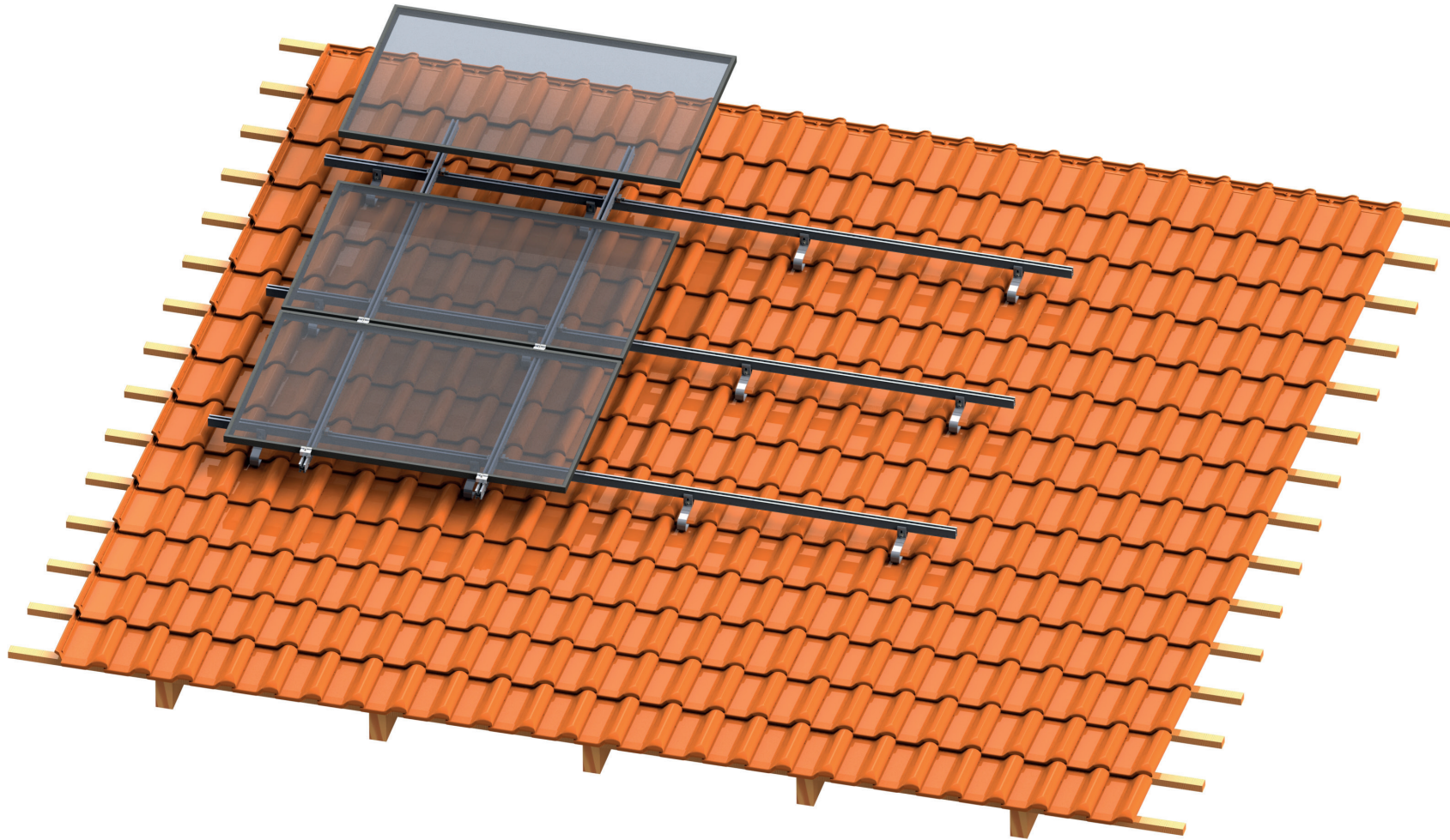

# MOUNTING TRUSS PROFILES IN A LATTICE ARRANGEMENT

1

## MOUNTING THE 'BASIS RAIL' TRUSS PROFILE

Mount the 'Basis Rail' truss profile horizontally, parallel to the ridge of the roof with the correct side up, and tighten to a torque of 15Nm.

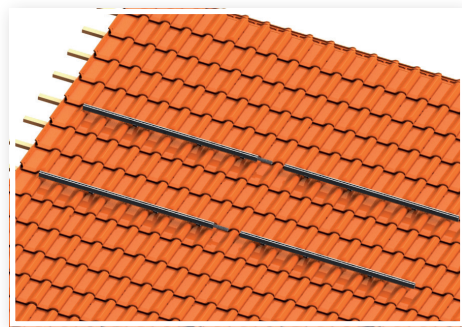

2

## MOUNTING THE CROSS-CONNECTOR

Rotate the cross-connector into the 'basic rail' and tighten to a torque of 15Nm.

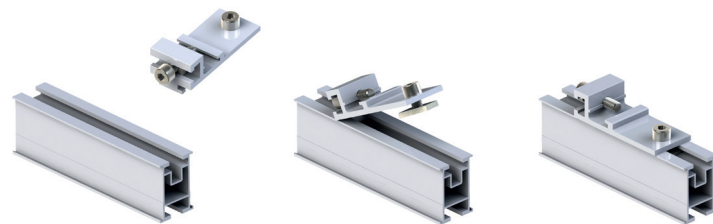

**Please note:** If the 'Basis Rail' profiles are mounted vertically, parallel to the side ends of the roof, the truss profile fixing screw on the cross-connector should always be pointing in the direction of the roof ridge.

3

## MOUNTING THE 'MODULE RAIL' TRUSS PROFILE

Mount the 'Module Rail' truss profile vertically on the cross-connector, parallel to the side edges of the roof with the correct side up, and tighten to a torque of 15Nm.

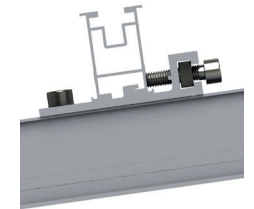

4

## CONNECT THE TRUSS PROFILES

Necessary when the width of the module field is greater than the length of the truss profile.

Push the profile connector halfway into the first truss profile, then connect the second truss profile to the profile connector.

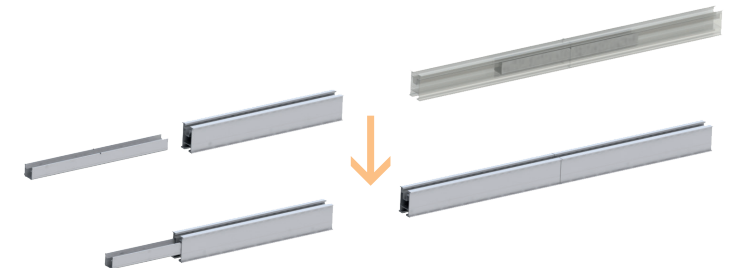



# MOUNTING THE TRUSS PROFILES IN A LATTICE PATTERN

5

## FITTING THE END CAPS

Press the end caps into the open ends of the profiles.

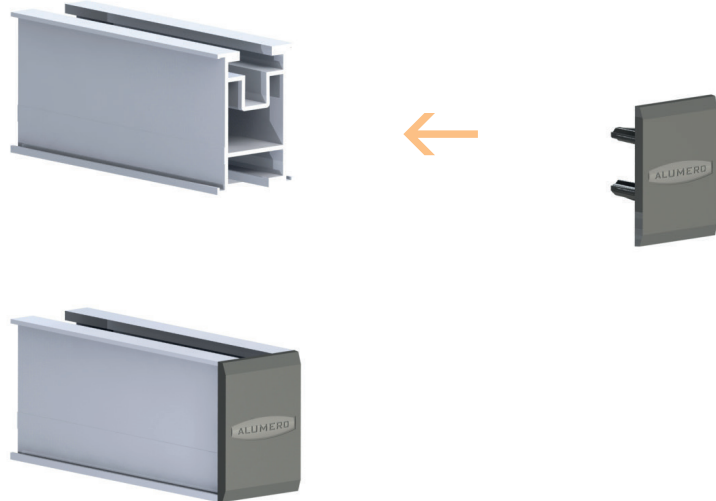

!

### Please note:

- Every truss profile must be attached in at least two places!
- Truss profile end contact surfaces must not be situated at points of attachment.

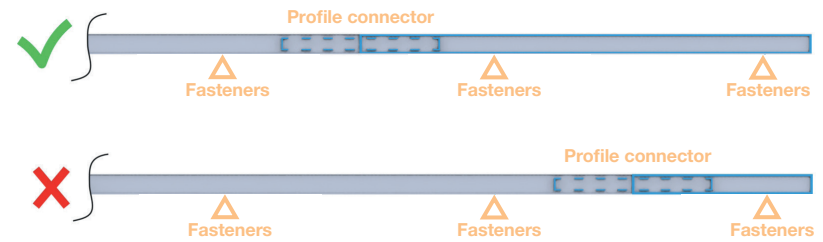

- Truss profile length: **max. 12m!**
- Ensure an expansion joint of at least **5cm** is included at a maximum of every **12m!**
- Extensions of the truss profiles beyond the final point of attachment according to sketch! These protrusions should be the same length at either end.

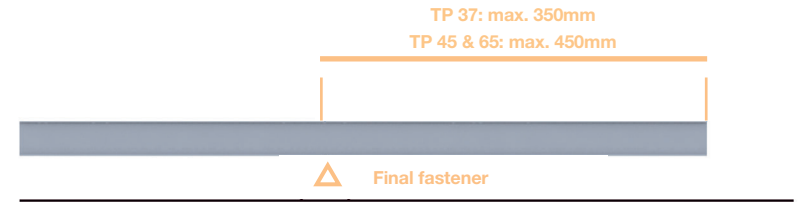

- Measure the correct positions for the profile connectors according to the Solar.Pro. Tool project report and optionally **screw down** the profile connector.



# MOUNTING MODULES

1

## MOUNTING THE END CLAMPS

Begin with the bottom row of the module. Lift the first module onto the truss profiles and position correctly.

Click in the end clamp by slightly tilting, and slide along to the module frame. Tighten hex screw to a torque of **15 Nm**.

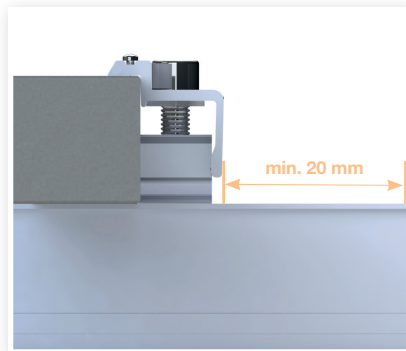
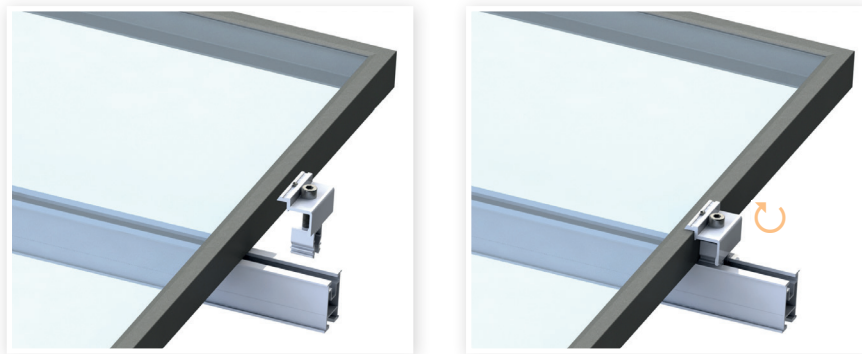

**Please note:** The end clamps must be attached at least 20mm from the end of each mounting profile.



**Please note:** If using end clamps with threaded plates, please ensure the plate is positioned at 90° to the profile channel.

2

## MOUNT THE MIDDLE CLAMP

Click the middle clamp onto the frame of the previous module at a slight angle. Move the module along until the modules are sitting pressed up to each other! Tighten hex screw to a torque of **15Nm**.

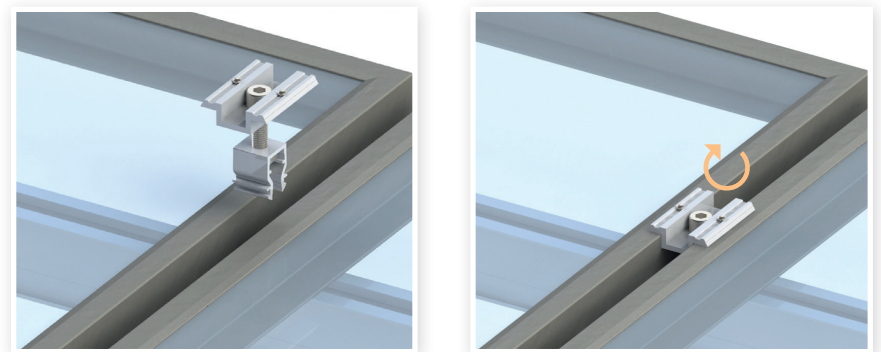

As described, each final module on a module row must be mounted with end clamps. The same applies to the remaining rows of modules.

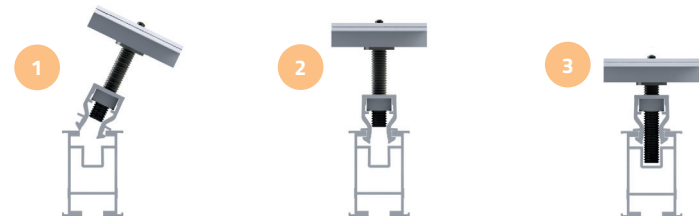

**Please note:**

- Ensure there is a gap of at **least 20mm** between the clamp and the end of the truss profile
- Middle clamps must not be mounted right at the end of the profiles!
- Modules must only be clamped in the sections prescribed for attachment! These can be found by consulting the manufacturer's respective module data sheet.
- Horizontal and vertical gaps between the modules must be around **20mm!**

**MOUNTING WITH AL13 X ROOF HOOKS**  
**VERTICAL MODULE ARRANGEMENT, LATTICE**

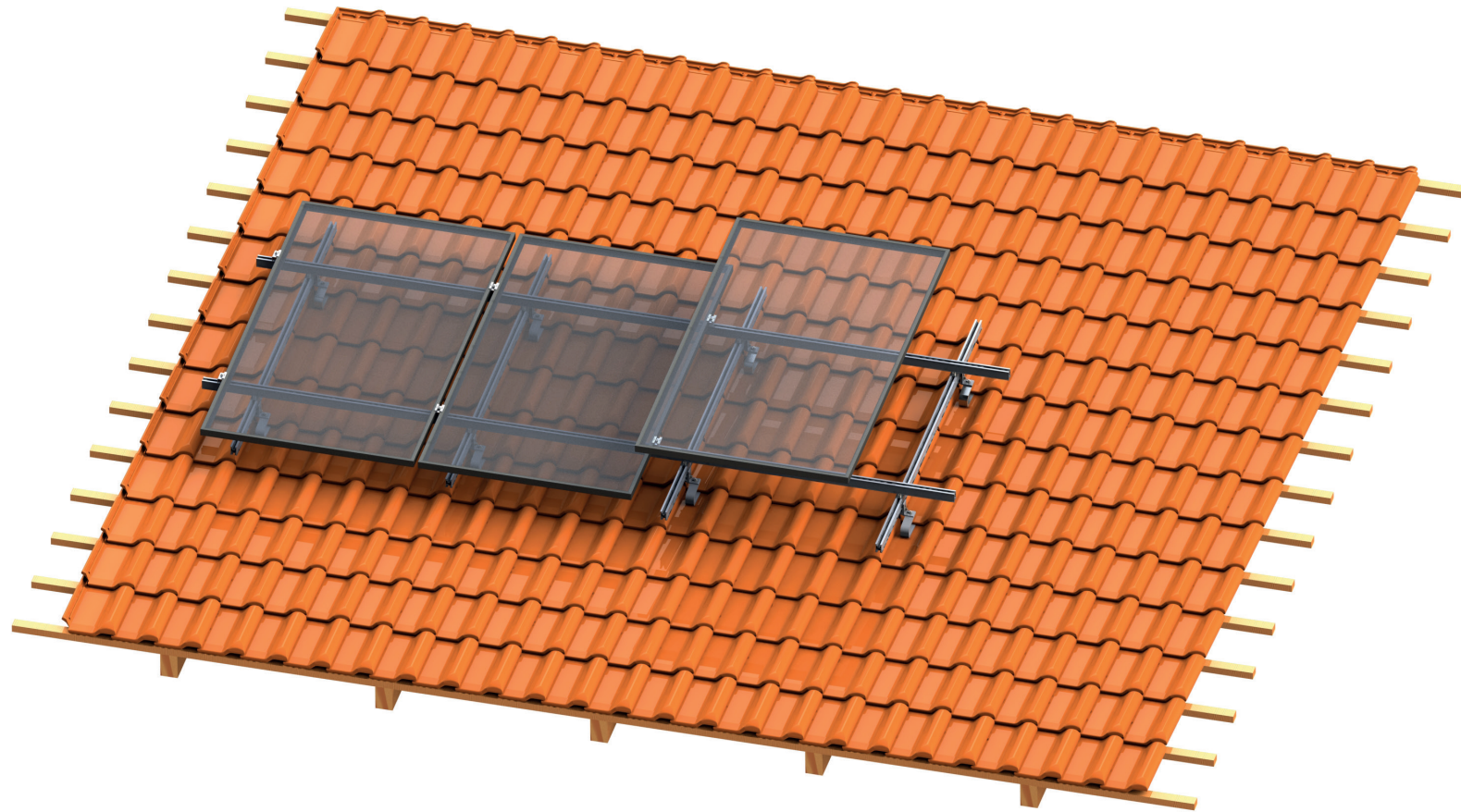

# MOUNTING AL13 X ROOF HOOKS

1

## MEASURE AND MARK POSITIONS

Measure and mark the positions of the roof hooks on the roof using the **Solar.Pro.Tool project report** and remove the roof tiles over each rafter.

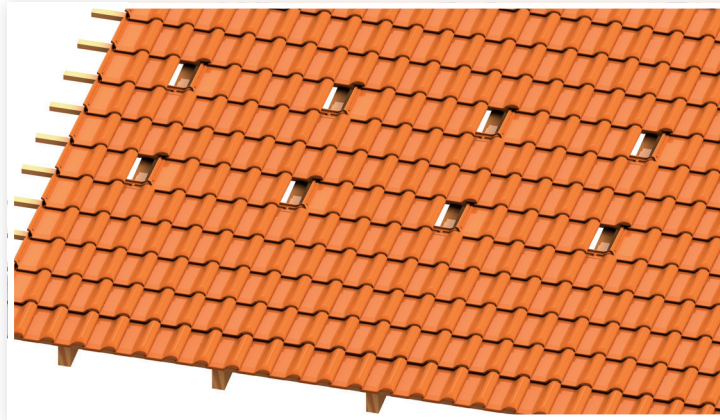

Modules must only be clamped in the **sections prescribed for attachment**. These can be found by consulting the manufacturer's respective module data sheet.

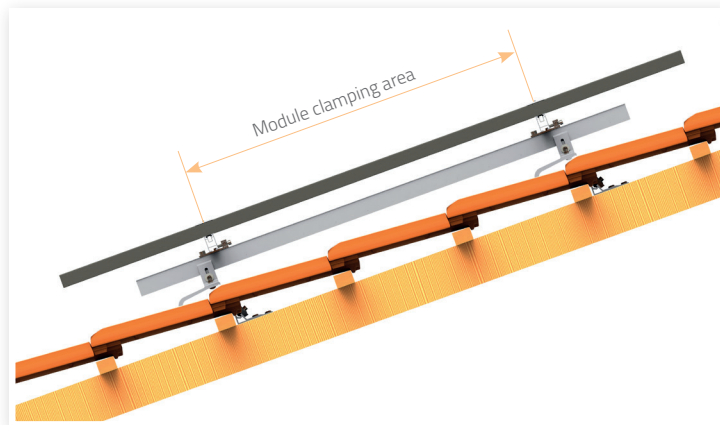

2

## MOUNTING AL13 X ROOF HOOKS AND TRUSS PROFILES

The mounting of the AL13 X is conducted as described on pages 7, 8 and 9. Mount the **'Basis Rail'** truss profile vertically onto the roof hooks, parallel to the side ends of the roof and with the correct side up, and tighten the fixing screws to a torque of **15Nm**.

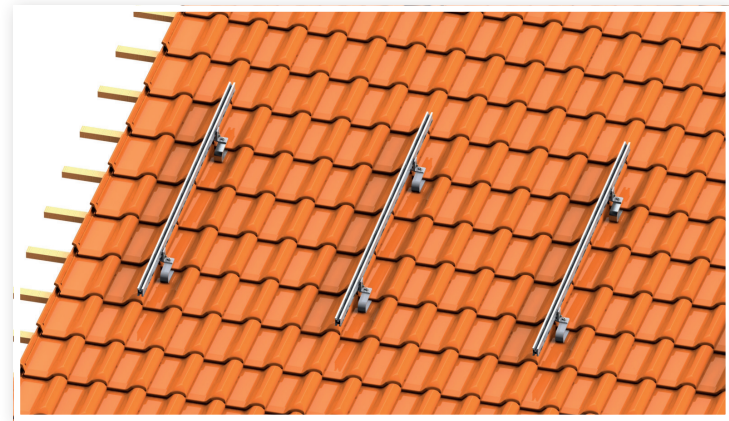

3

## MOUNTING THE CROSS-CONNECTOR

Rotate the cross-connector into the **'basic rail'** and tighten to a torque of **15Nm**.

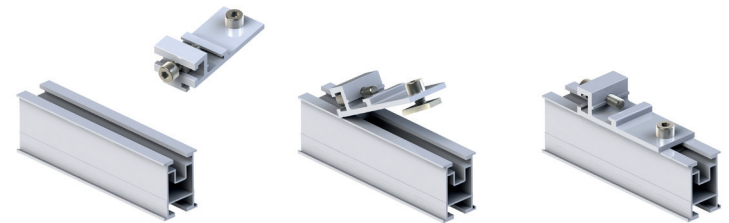

**Please note:** If the **'Basis Rail'** profiles are mounted vertically, parallel to the side ends of the roof, the truss profile fixing screw on the cross-connector should always be pointing in the direction of the roof ridge.

# MOUNTING AL13 X ROOF HOOKS

4

## MOUNTING THE 'MODULE RAIL' TRUSS PROFILE

Mount the 'Module Rail' truss profile horizontally on the cross-connector, parallel to the roof ridge with the correct side up, and tighten to a torque of 15Nm.

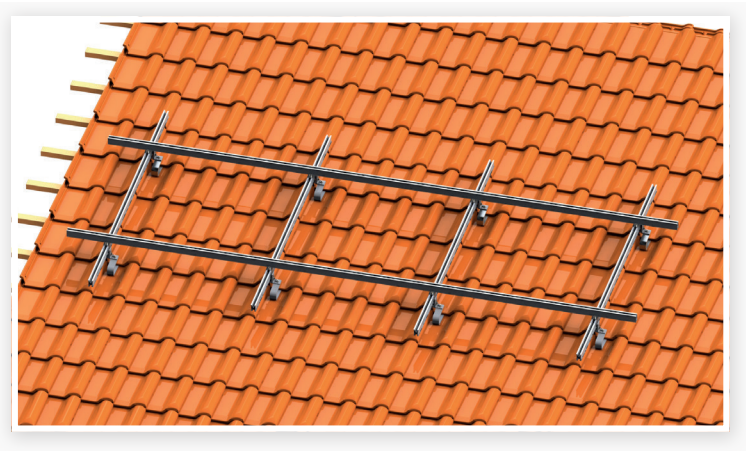

We recommend mounting the modules vertically on a lattice framework.



!

**Please note:**

- Every truss profile must be attached in at least two places!
- Truss profile end contact surfaces must not be situated at points of attachment.

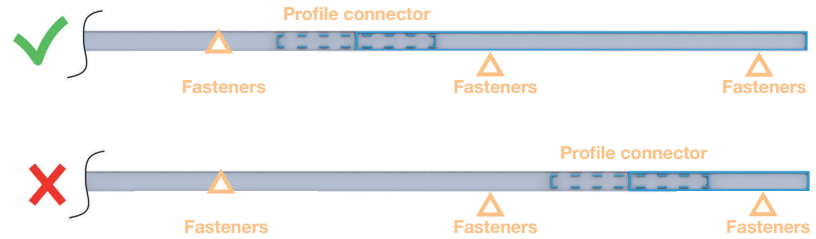

- Truss profile length: **max. 12m!**
- Ensure an expansion joint of at least **5cm** is included at a maximum of every **12m!**
- Extensions of the truss profiles beyond the final point of attachment according to sketch! These protrusions should be the same length at either end.

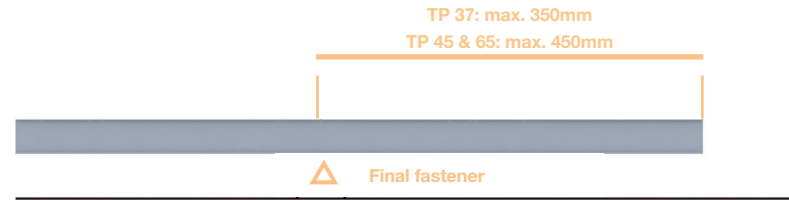

**Info:** When using **AL13 X roof hooks** there is also the option of mounting the modules horizontally on single-direction rail rows. Modules must only be clamped in the **sections prescribed for attachment**. These can be found by consulting the respective module's installation instructions.

# MOUNTING MODULES

1

## MOUNTING THE END CLAMPS

Begin with the bottom row of the module. Lift the first module onto the truss profiles and position correctly.

Click in the end clamp by slightly tilting and slide along to the module frame. Tighten to a torque of **15 Nm** with the hex key.

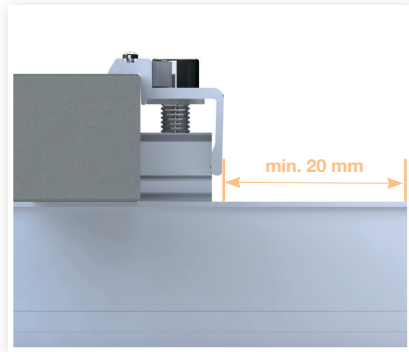
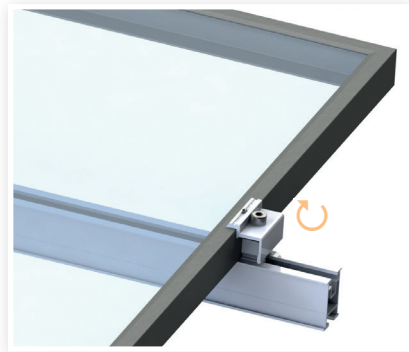
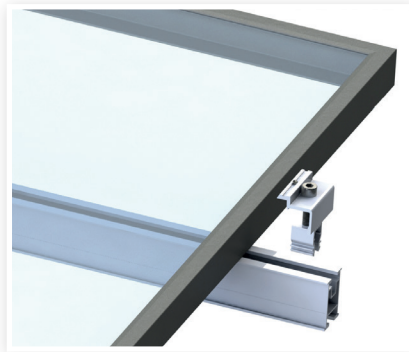

**Please note:** The end clamps must be attached at least 20mm from the end of each mounting profile.



**Please note:** If using end clamps with threaded plates, please ensure the plate is positioned at 90° to the profile channel.

2

## MOUNT THE MIDDLE CLAMP

Click the middle clamp onto the frame of the previous module at a slight angle. Move the module along until the modules are sitting pressed up to each other! Tighten with a hex key to a torque of **15Nm**.

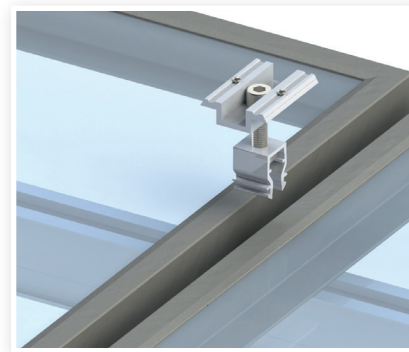

As described, each final module on a module row must be mounted with end clamps. The same applies to the remaining rows of modules.

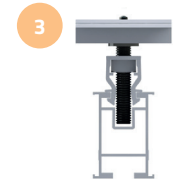
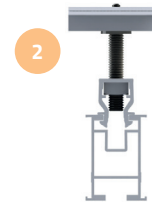
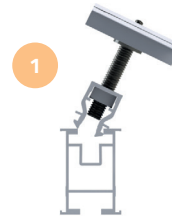

**Please note:**

- Ensure there is a gap of at **least 20mm** between the clamp and the end of the truss profile
- Middle clamps must not be mounted right at the end of the profiles!
- Modules must only be clamped in the sections prescribed for attachment! These can be found by consulting the manufacturer's respective module data sheet.
- Horizontal and vertical gaps between the modules must be around **20mm!**

## ATTACHING THE MODULE CABLES

1

Module cables must not hang freely or lie unsecured on the roof surface. Press the clip attached to the cable tie into a truss profile channel and bind the cables together with the cable tie.

Remove the clip from the profile channel by sliding it out sideways.

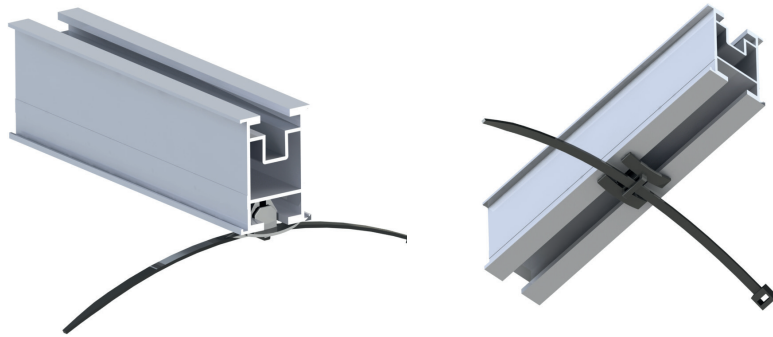

## EQUIPOTENTIAL BONDING

Equipotential bonding between the individual parts of the PV roof-mounting system is subject to respective national directives. The following section shows one means of earthing the ALUMERO tiled roof system. The applicable cable thicknesses and full earthing plans for each country cannot be provided in these instructions. They must be calculated and executed by the certified plumbers and electricians you choose for installation. There are other acceptable means of correctly earthing your infrastructure on top of the ones we have detailed here.

1

### EARTHING ROWS OF TRUSS PROFILES

Mount a wire clamp to the lower profile channel of every truss profile row. Place the aluminium wire conductor in the wire clamp and secure it by screwing it tight. This ensures every row of modules conducts to every other.

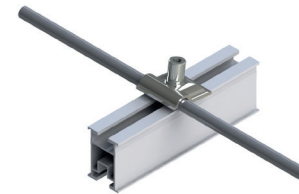

Attaching the aluminium wire with a wire clamp

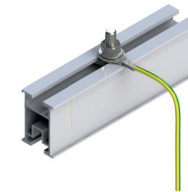

Attaching the earthing wire with an anchor bolt

## 2

### EARTHING MODULES

The module manufacturer specifies in the respective data sheet as to whether the particular module needs to be earthed. If this is the case, equipotential bonding for your modules can be implemented in the following ways – as recommended by ALUMERO:

ALUMERO end and middle clamps can be used with built-in pin switches to integrate your modules into the equipotential bonding network. These pins are situated in the clamps and puncture the anodised layer of the module frames, thus connecting up all the rows of modules into a circuit.



Click end clamp  
with a pin switch



Click middle clamp  
with a pin switch

# DONE!



All graphic representations of products provided in these installation instructions are for demonstration purposes and are not perfectly-scaled images. Subject to changes and errors!



# PLEASE TAKE NOTICE OF THE FOLLOWING INFORMATION!

We recommend you read the following information very carefully as it is of immense importance for handling the product. Please also make sure you are familiar with the safety guidelines and rules for the other components within the system.

# SAFETY INFORMATION AND WARNINGS

The AS 2.1 pitched roof system is intended solely to carry PV modules. Any other applications of the system shall be considered examples of misuse. Correct use of this infrastructure also entails adherence to the guidelines and recommendations in these instructions. ALUMERO shall accept no liability for damages resulting from neglect to adhere to the installation manual, particularly in cases of incorrect use of the product.

- ALUMERO shall under no circumstances accept liability for losses of performance suffered by the system, or damage to the system, whatever their nature.

All work carried out on the PV system should be conducted in full compliance with these instructions. Installation, commissioning, servicing and repair may only be conducted by specialists with recognised relevant certification and qualifications.

Please observe all current and applicable rules and safety advice.

### Observation of these accident prevention regulations is mandatory:



- BGV A 1 – General official guidelines
- BGV A 3 – Electric systems and items in operation
- BGV C 22 – Construction and installation work (PPE for fall prevention & falls)
- BGV D 36 – Ladders and steps
- Trade association rules on health and safety at work BGR 203 for work on roofs, and DIN EN 516 regarding infrastructure required to work on roofs, work clothing and work safety rules according to trade association regulations



### You are obliged to adhere to the following DIN norms:



- DIN 18299 – General regulations for all types of construction work
- DIN 18338 – Roof covering and roof sealing work
- DIN 18360 – Metal structure work and construction
- DIN 4102 – Combustibility and flammability of building materials and components

Work on systems made by Alumero Systematic Solutions GmbH may only be conducted by authorised personnel. The system operator is obliged to observe the following safety conditions:



- We require that the AS 2.1 pitched roof system components and the outer surface of the roof installed are inspected and serviced at least once a year. At a minimum, the following points must be checked:
  - » All mechanical connections must be checked to ensure they are stable, secure and correctly tightened
  - » The situation of the system on the roof, and the condition of the system itself as regards deformation
  - » Cabling must be inspected to ensure there is no damage
  - » PV modules must be inspected to ensure there is no damage

- The frames may only be mounted by personnel with relevant qualifications, trade skills and basic knowledge of the mechanics involved.



- Make sure personnel charged with mounting, installation and servicing on your behalf are capable of evaluating the hazards and recognising the possible dangers.

- This installation manual is integral to the product itself and must be available at all times during mounting and installation.



- Ensure all personnel charged with mounting and installing systems have read and understood the installation instructions, and particularly the safety information, before work commences.

- There must be absolute compliance with the rules and regulations of the responsible trade association, local work safety directives and all applicable rules for technical equipment.



- Only suitable lifting devices and ladders must be used for mounting purposes. The use of ladders that are only leaned against structures is not permitted

- Evaluation of the existing structural statics of the building and roof in question must be conducted by a certified structural engineer to ensure existing structures can bear the additional weight and forces caused by a PV system.

- Make sure you are aware that ALUMERO Systematic Solutions GmbH applies maximum weight limits to take various eventualities into account, such as the need to climb on roofs to clear snow and reduce weight.

## PRODUCT GUARANTEE / EXCLUSION OF LIABILITY

Information about dimensioning in these instructions is provided from past experience. Binding installation statics for frames and structures can be generated using ALUMERO Solar.Pro.Tool.

The company mounting and installing the system is responsible for ensuring all such work is executed correctly. ALUMERO Systematic Solutions GmbH accepts no liability for the reliability of dimensioning information provided in system sales offers.



The company mounting and installing the system is responsible for the mechanical sustainability of connections mounted on, and to the outside of, the building, particularly in terms of watertightness. ALUMERO Systematic Solutions GmbH's components are designed to correspond with the latest technical standards and to cope with the loads and forces to which such systems are commonly exposed. On submitting an inquiry/order you are required to use the project questionnaire to inform ALUMERO Systematic Solutions GmbH in writing/print about all the general technical conditions prevailing on-site, such as support structure details, snow load zone, building heights, wind loads etc.

ALUMERO Systematic Solutions GmbH accepts no liability for the incorrect handling of parts built into the system.

In order to avoid corrosion, the aluminium construction may only come into contact with media (solid, liquid, gaseous) that have a PH value from 4,5 till 8,5.

If used correctly, dimensioned within statutory static tolerance levels calculated for the site, and operated under normal local weather and environmental conditions, ALUMERO Systematic Solutions GmbH grants a 2-year product guarantee for the working life and durability of the support frame systems. It is valid for generally prevalent meteorological and environmental conditions.

Materials and finishing guarantee: ALUMERO Systematic Solutions GmbH provides a 10-year guarantee on all materials and finishing. For more information, please see the specific guarantee conditions.

## INFORMATION ABOUT ELECTRICAL INSTALLATION



All work with electricity, or on devices carrying electrical currents, must be conducted by trained electricians. Compliance must be guaranteed with all the applicable DIN norms, VDE rules, VDEW guidelines, VDN directives, accident prevention rules and the directives of the local energy suppliers.

- DIN VDE 0100: Installation of high-voltage systems with nominal voltages of up to 1000 V)
- VDEW directive: For the parallel operation of self-generation systems with the EVU low voltage mains system
- VDI 6012 directive for decentralised energy systems in buildings: Photovoltaics
- Info sheet for the VDEW directive: 'Low-Voltage Mains Self-Generation Systems'
- VDN directives on 'Low-voltage mains'
- DIN/VDE directives, DIN/VDE 0100 'The Installation of High-Voltage Systems Using Mains Voltages of up to 1000 V', particularly VDE 0100 part 410: 'Prevention of Direct or Indirect Contact' (DC voltage > 120 V, < 1000 V) and 'Trade Association Accident Prevention and Protection' VBG4 'Electrical Systems and Components'
- DIN VDE 0100-540: Selection and installation of earthing, conductors and equipotential bonding conductors
- VDE 0185 on the establishment of a lightning conduction system and VDS 2010

## KEY WARNINGS



Solar modules generate electricity as soon as they are exposed to sunlight. Hence, they are constantly electrically 'live'. Fully-insulated plug and socket contacts provide protection in case of physical contact. However, the following rules must be observed in contact with solar modules:

- Do not place any electrically conductive items in the plugs or sockets.
- Do not install solar modules or power cables if plugs or sockets are wet.
- Be extremely careful when carrying out any work on power cables.
- Do not conduct any electrical installation work where there is moisture.



Even when there is only a small amount of light available, serially-connected solar modules may still use very high direct current voltages, and contact with these can be lethal. Please be aware of the secondary injuries and damage caused by electric shocks.

Even when switched off inverters can still pass on powerful electrical charges on contact:

- Take special care when working with the inverter and power conduits.
- Before further work is conducted, it is essential to adhere to offline intervals recommended by the manufacturer once the inverter has been switched off to ensure the power in high-voltage components has time to discharge.
- Please adhere to all installation specifications provided by the manufacturer of the inverter.



Lethal arc flashes may be generated when disconnecting a power conduit, such as when disconnecting an inverter from the DC power supply while still bearing a current:

- Never disconnect the solar generator from the inverter while still connected to the mains.

## NORMS AND GUIDELINES

All norms and guidelines presented here are published and intended for use in Germany. The guidelines provided in each respective edition must be complied with. Please note that installations outside Germany will also be subject to additional national norms and guidelines.

## HOW TO INSTALL THE FRAMEWORK

All roof area installations must be carried out in accordance with currently valid technical building standards, particularly those specified in the DIN norms and the requirements formulated in the 'German Roofers' Rulebook'.



- Check to ensure all screwed attachments are correctly tightened.
- Adhere to the suggested torque values.
- Regardless of the testability of the statics, prior to every installation it is essential to ensure the product complies with DIN EN 1991 statics requirements on site.
- DIN Norm EN 1991 'Forces Affecting Load-Bearing Structures' – and all accompanying national application documents.
  - Part 1-1: Weight, weight distribution, counterweighting and payloads in above-ground construction
  - Part 1-3: Snow loads
  - Part 1-4: Wind loads
- DIN Norm EN 1990: 'The Fundamentals of Support Structure Planning' – and all accompanying national application documents.
- The structure on which the system is mounted is evaluated for compliance under DIN EN 1993 'Measurement and Construction of Steel Structures', and DIN EN 1999 'Measurement and Construction of Aluminium Support Structures'.
- Ensure suitability of the substructure for load-bearing purposes, like dimensions, current conditions, relevant material properties, general load-bearing structures – and of all individual layers affected such as layers of insulation.
- Ensure the flow and drainage of rainwater is not obstructed.
- Always take the physical effects on building work into account, such as the risk of dew penetrating layers of insulation.



## PRODUCT LIABILITY

The technical documentation is an integral part of the product. Alumero Systematic Solutions GmbH shall bear no liability for damages that occur due to non-adherence to the installation instructions, particularly to safety information, or due to misuse of the products.

YOUR DEALERSHIP

**ALUMERO**

# CONGRATULATIONS & WELL DONE!

## CONTACT HEADQUARTERS

ALUMERO Systematic Solutions GmbH  
Sonnenweg 1-2  
5162 Seeham - Österreich

T +436217 / 68 41 - 0  
F +436217 / 68 41 - 41  
solar@alumero.at  
www.alumero.at