

DATA SHEET

AOL 100 LED 5K white

Order description

AOL 100 LED 5K white

Item number

EL10750007

GTIN

4015120750007



Product description

- Automatic light with built-in motion detector
- Design lamp made of die-cast aluminium and plastic
- 14 W, light colour approx. 5000 K white
- 140° field of detection, range up to 10 m at an installation height of 1.8 m

Technical data

GENERAL	
Conformity	CE, RoHS, WEEE
Warranty	3-year
ATTACHMENT	
Installation type	Surface mounting
Installation position	Wall
HOUSING	
Dimensions	length 143 mm x width 104 mm x Height/Depth 205 mm
Weight	570 g
Material	Aluminium and UV-stabilised plastic
Protection type	IP55
Permissible ambient temperature	-25 °C...+50 °C
Colour	white, similar to RAL 9016
Connection	2,5 mm ² / 1,5 mm ²
Glow wire test in accordance with IEC 60695-2-10	650 °C - 30 s
ELECTRICAL VERSION	
Protection class	II
Nominal voltage	230 V / 50 Hz
Stand-by consumption	0,5 W

LIGHT

Diffusor	opal
Light emission	direct
Beam angle	90 °
Flicker factor	<10 %
Rated output	14 W
Luminous Flux (light)	770 lm
Luminous efficacy	55 lm/W
Colour temperature	5000 K
Colour rendering index Ra	> 70
Rated life time L70B10 at 25 °C	80000 h
Rated life time L70B50 at 25 °C	100000 h
Rated life time L80B10 at 25 °C	50000 h
Rated life time L80B50 at 25 °C	65000 h
Rated life time L90B10 at 25 °C	25000 h
Rated life time L90B50 at 25 °C	30000 h
Energy efficiency class	A++ to A

SENSORS

Detection angle	140°
Detection range diagonally	10 m
Field of detection	31 m ²
Recommended installation height	1,8 m
Level of brightness	5 - 1000 lx

DATA SHEET

AOL 100 LED 5K white

Order description

AOL 100 LED 5K white

Item number

EL10750007

GTIN

4015120750007

Scale drawing

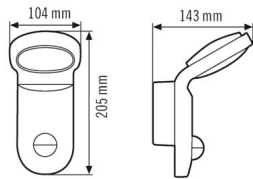

Field of detections

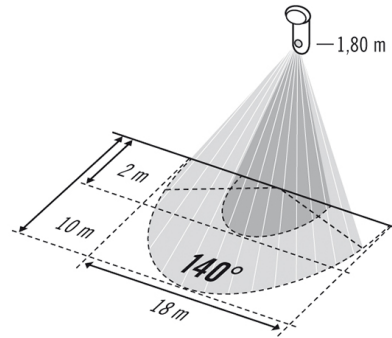

- Head-on to detector
- Passage area / diagonally to detector

Light distribution

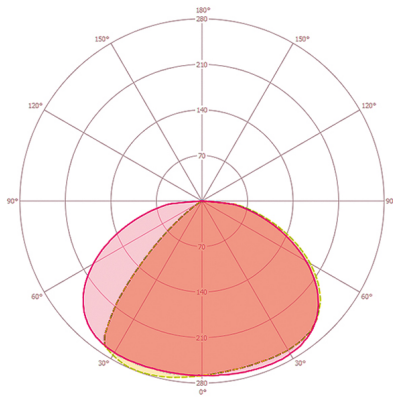

Circuit diagram

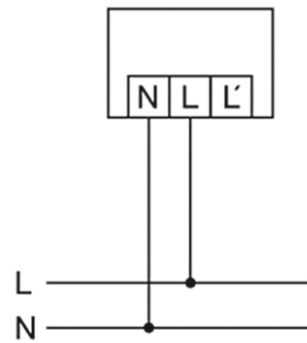

Standard operation

Circuit diagram

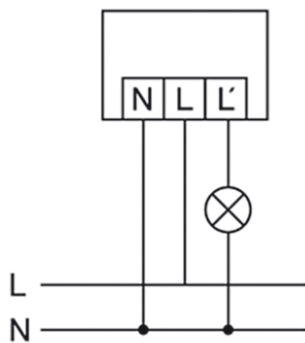

Standard operation with additional connection of external loads