

**People**  
PL6721

**COMELIT**<sup>®</sup>  
WITH • YOU • ALWAYS

FULL USER MANUAL

---

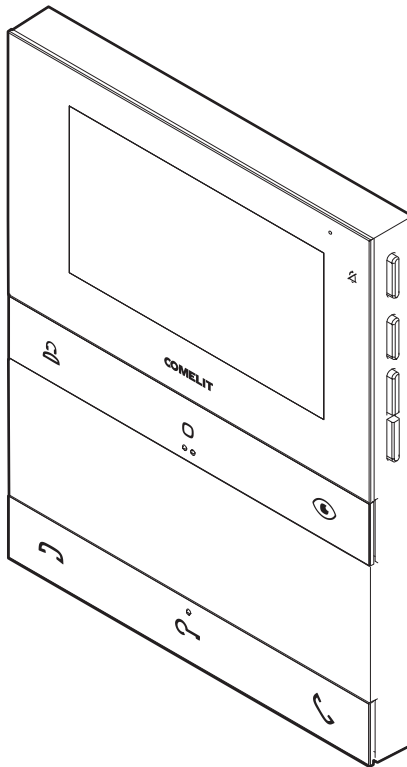

**Join us  
in taking care  
of our planet**

***Thank you for choosing Comelit!***

*You have made a sustainable choice by purchasing a safe, durable and high quality product.*



**Think before  
you print**

*Help us to save the planet.*

*Think of the planet before printing this document.*



# People door entry monitor

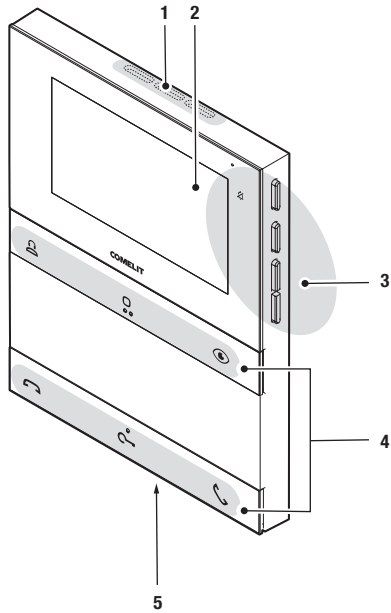

1. Speaker.
2. 4.3" / 16:9 LCD screen.
3. Mechanical side buttons.
4. Mechanical front buttons, with touch guides for sight impaired users on the middle buttons of each row.
5. Microphone.

## Front buttons - factory programming



### Standard call to switchboard \*

- ▶ Press the button to send a call to the porter switchboard.



### Generic actuator \*

- ▶ Press the button to activate a generic actuator (art. 1256) or the relay for the external entrance panel.



### Self activation \*

- ▶ Press the button to access real-time viewing of the images on the outdoor entrance panel camera.



### End of communication

- ▶ Press the button to end the audio communication.





### Lock-release \*

- ▶ Press the button to activate the door lock.

#### Door opening on call

*This button can also be used to enable "Automatic lock-release on receipt of call", which allows automatic activation of the lock-release relay on receipt of a call originating from the external entrance panel.*

- √ The function must be authorised by the installer via the MyComelit app.
- ▶ When the door entry monitor is in standby, press  for 5 seconds to enable/disable "Automatic lock-release on receipt of call" mode.
  - » A confirmation tone will play.
  - » The steadily lit LED  indicates that the function is active.





### Start communication

- ▶ Press the button to activate communication.

#### Automatic answer

*This button can also be used to enable "Automatic answer", which allows automatic activation of the audio on receipt of a call originating from the external entrance panel.*

- √ The function must be authorised by the installer via the MyComelit app.
- ▶ When the door entry monitor is in standby, press  for 5 seconds to enable/disable "Automatic answer" mode.
  - » A confirmation tone will play.
  - » The steadily lit LED  indicates that the function is active.

\* To change the factory programming for the buttons, please contact your installer.

## Side buttons

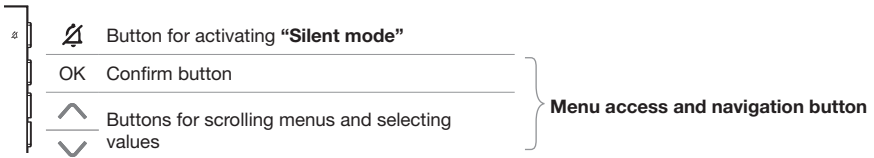

## ACTIVATING “SILENT MODE”

*Silent mode can be used to exclude the ringtone on receipt of a call from the outdoor entrance panel and from the switchboard.*

- ▶ Press **the button** to activate/deactivate **Silent mode**.
- » *The red LED indicates that the function is active.*

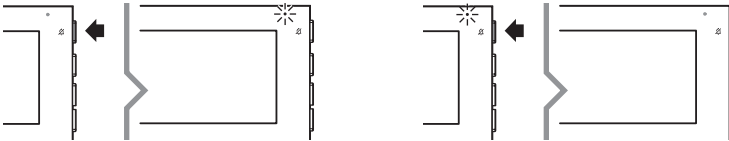

## ACCESSING AND NAVIGATING MENUS

- ▶ Press **one** of the buttons below to access the **user menu**.

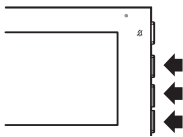



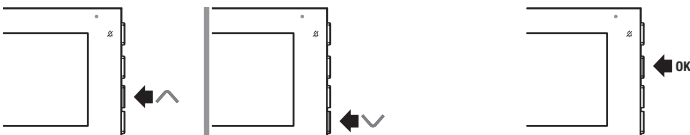

- ▶ Press **^** and **v** to scroll through the menu and/or select the values, then press the confirm button to confirm the selection.



### User menu options

	Exit
	Call volume adjustment
	Select ringtone upon call from external entrance panel
	Audio volume adjustment
	Brightness control
	Contrast adjustment
	Colour adjustment

## Indicator LED

	<b>Red LED</b>	<b>Flashing:</b> communication taking place. <b>Flashing:</b> incoming call/communication taking place.
	<b>White LED</b>	<b>Flashing with door entry monitor in standby:</b> "Door open" indication. <b>Lit steadily with door entry monitor in standby:</b> "Automatic lock-release on receipt of call" mode enabled.
	<b>Green LED</b>	<b>Flashing:</b> incoming call. <b>Lit steadily:</b> communication taking place. <b>Lit steadily with door entry monitor in standby:</b> "Automatic answer" mode enabled.
	<b>Red LED</b>	<b>4 flashes:</b> system busy. <b>Lit steadily:</b> silent mode enabled

## Example: selecting the ringtone upon call from external entrance panel



1. Press **one** of the buttons below to access the **user menu**.

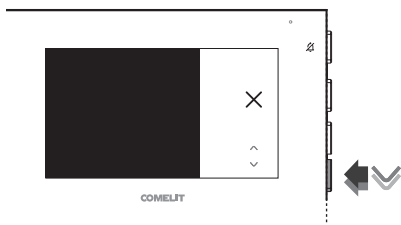

2. Press **∨** repeatedly until the **🎵** icon appears.

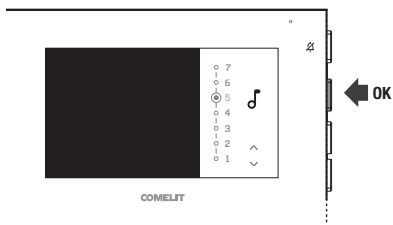

3. Press the confirm button.

4. Press **∧** and **∨** to select the desired ringtone.

» *The ringtone will play.*

5. Press the confirm button to save the programming.

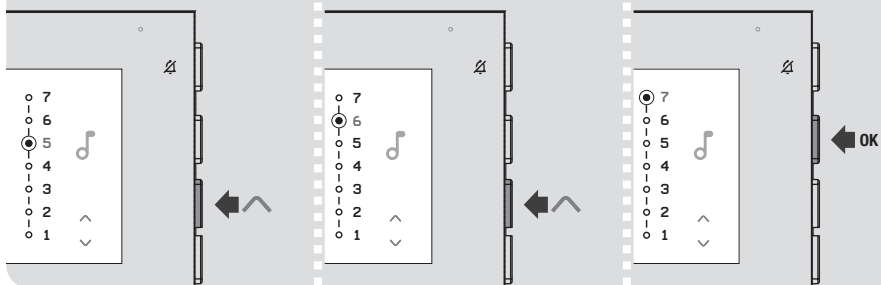

# Warning

## Intended use

This Comelit product is designed and manufactured for use in the creation of audio and video communication systems in residential, commercial, industrial and public buildings.

## Installation

All activities connected to the installation of Comelit products must be carried out by qualified technical personnel, with careful observation of the indications provided in the Manuals / Instruction sheets supplied with those products. The product must be installed to the highest standards.

## Wires

Disconnect the power supply before carrying out any operations on the wiring. Use wires with a cross-section suited to the distances involved, observing the instructions provided in the system manual. We advise against running the system wires through the same duct as power cables (230V or higher).

## Safe usage

To ensure Comelit products are used safely:

- carefully observe the indications provided in the Manuals / Instruction sheets,
- make sure the system created using Comelit products has not been tampered with / damaged.

## Maintenance

Comelit products do not require maintenance aside from routine cleaning, which should be carried out in accordance with the indications provided in the Manuals / Instruction sheets.

Any repairs must be carried out:

- for the products themselves, exclusively by **Comelit Group S.p.A.**,
- for the systems, by qualified technical personnel.

Do not use alcohol or aggressive products for cleaning purposes.

## Disclaimer

**Comelit Group S.p.A.** does not assume any responsibility for

- any purpose other than the intended use,
- failure to observe the indications and warnings contained in this Manual / Instruction sheet.

**Comelit Group S.p.A.** reserves the right to change the information provided in this Manual / Instruction Sheet at any time and without prior notice.

## Directives



The manufacturer, **Comelit Group S.p.A.**, hereby declares that this equipment conforms to the applicable directives. The full EU conformity declaration is available on the web page for the product.



In accordance with art. 26 of Italian Legislative Decree dated 14th March 2014, no. 49 "Implementation of directive 2012/19/EU on Waste Electrical and Electronic Equipment (WEEE)", the "crossed-out wheelee bin" symbol indicates that at the end of its useful life, this product must be separated from other waste before collection for disposal. The user should therefore take the exhausted appliance to suitable local collection centres for waste electrical and electronic products. As an alternative to handling this process yourself, you can take the appliance to your local equipment dealer when purchasing a new equivalent product. Electronics dealership businesses covering an area of 400 m<sup>2</sup> are also obliged to accept waste electronic products smaller than 25 cm for disposal, without any obligation to purchase. Suitable separated waste collection for the subsequent reuse of the appliance sent for recycling, processing and environmentally conscious disposal helps to avoid potential negative effects on the environment and human health, and encourages the reuse and recycling of the materials used in the construction of the appliance.





CERTIFIED MANAGEMENT SYSTEMS



[www.comelitgroup.com](http://www.comelitgroup.com)

Via Don Arrigoni, 5 - 24020 Rovetta (BG) - Italy

1st edition 07/2023  
code 2G40003125