

Leistungsschütze LA, Baugröße 3, 4 - 18,5kW



LA30101N

Schrack-Info

- Schütze von 4kW bis 18,5kW, 3- oder 4-polig
- K3-10 bis K3-22, maximal 4 frontseitige Hilfskontakte HN oder HA aufschraubbar
- K3-24 bis K3-40, maximal 4 frontseitige Hilfskontakte HN oder HA sowie 2 seitliche Hilfskontakte HB aufschraubbar
- 3-polige Schütze K3-10 bis K3-22 für den Anbau thermischer Überlastrelais der Type U12/16E..K3 geeignet
- 3-polige Schütze K3-10 bis K3-40 für den Anbau thermischer Überlastrelais der Type U3/32 geeignet
- 3-polige Schütze K3-24 bis K3-40 für den Anbau thermischer Überlastrelais der Type U3/42 geeignet
- 4-polige Schütze sind nicht für den Anbau von thermischen Überlastrelais geeignet
- Montage auf Tragschiene TS35 oder Montageplatte
- Weiteres Zubehör im Anhang



Mobil Code

		K3-10	K3-14	K3-18	K3-22	K3-24	K3-32	K3-40
Bemessungsisolationsspannung U_i	(VAC)	690						
Gebrauchskategorie AC-1 $\cos \varphi = 1$								
Bemessungsleistung bei 400VAC	(kW)	17,3	17,3	22,1	22,1	34,6	45	55,4
Bemessungsbetriebsstrom $I_n = I_b$ bei 40°C und 690VAC	(A)	25	25	32	32	50	65	80
Gebrauchskategorie AC-2 und AC-3								
Bemessungsleistung bei 400VAC	(kW)	4	5,5	7,5	11	11	15	18,5
Bemessungsbetriebsstrom I_n bei 380-400VAC	(A)	10	14	18	22	24	32	40
Umgebungstemperatur (Betrieb)	(°C)	-40 ... +60						
Einbaulage								
Normen und Bestimmungen		IEC 60947-4-1, EN60947-4-1						

		inkludierte Hilfskontakte
Bemessungsisolationsspannung U_i	(VAC)	690
Thermischer Nennstrom I_n bei 40°C und 690VAC	(A)	10
Gebrauchskategorie AC-15		
Bemessungsbetriebsstrom I_n bei 40°C und 230/440VAC	(A)	3 / 1,6
Gebrauchskategorie DC13¹⁾		
Bemessungsbetriebsstrom I_n bei 40°C bis 60/110/220VDC	(A)	3,5 / 0,5 / 0,1
Umgebungstemperatur (Betrieb)	(°C)	-40 ... +60
Normen und Bestimmungen		IEC 60947-5-1, EN 60947-5-1

1) Hilfskontakte elektroniktauglich entsprechend EN60947-5-4 für Nennspannung 24VDC (Prüfwerte 17VDC, 5mA). Kontakte zwangsgeführt.

Leistungsschütze LA, Baugröße 3, 4 - 18,5kW

Abmessungen

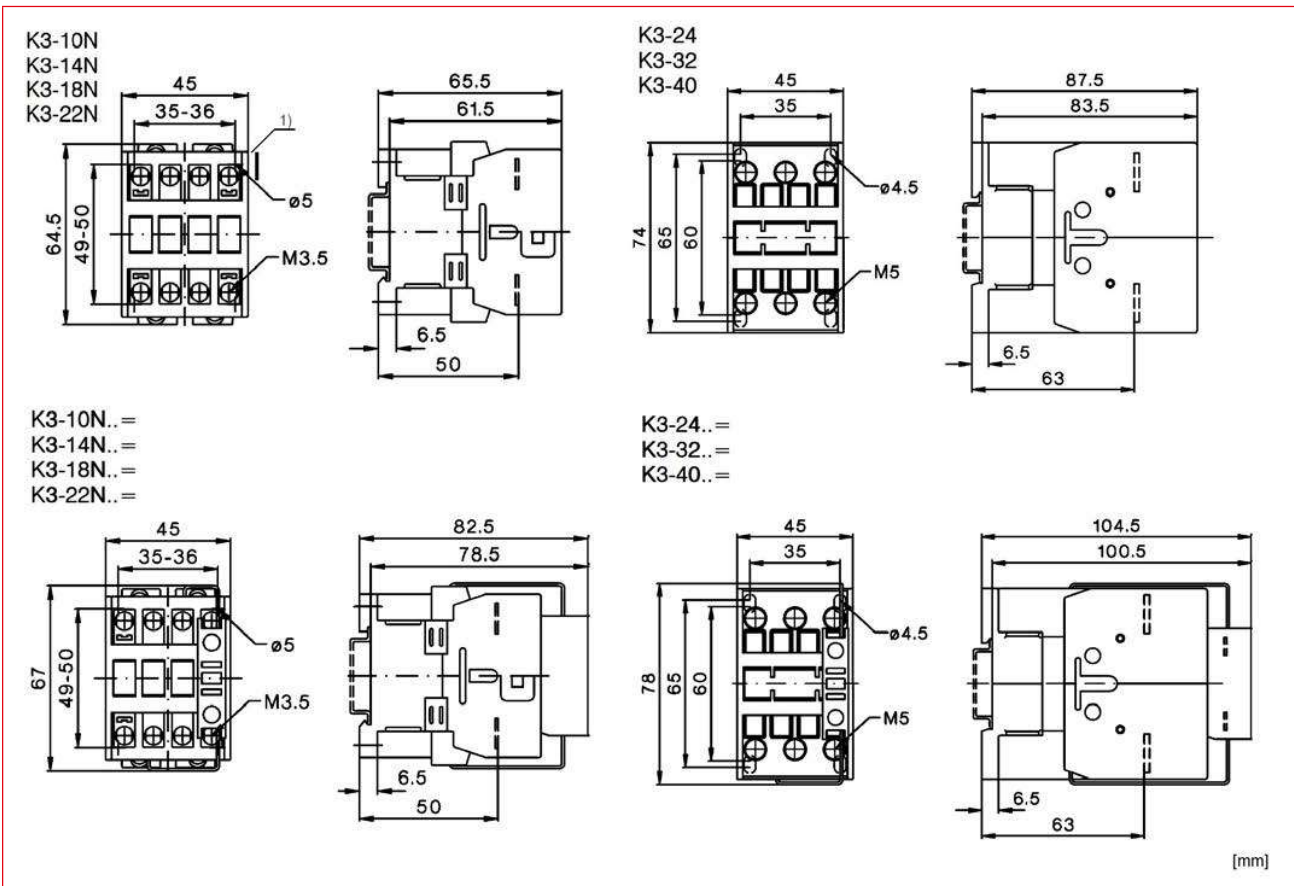

1) Mindestseitenabstände zu leitfähigen Teilen bei Spulenspannungen:
 500V $U_{imp}=6kV$ 2mm
 660-690V $U_{imp}=8kV$ 4,5mm

Schaltbilder

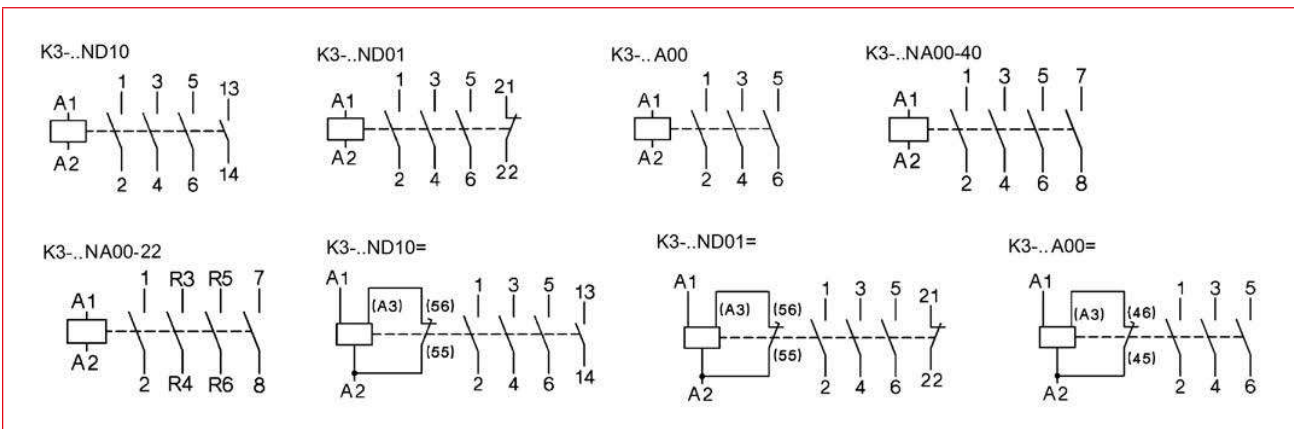

Elektromechanische Schütze Serie LA





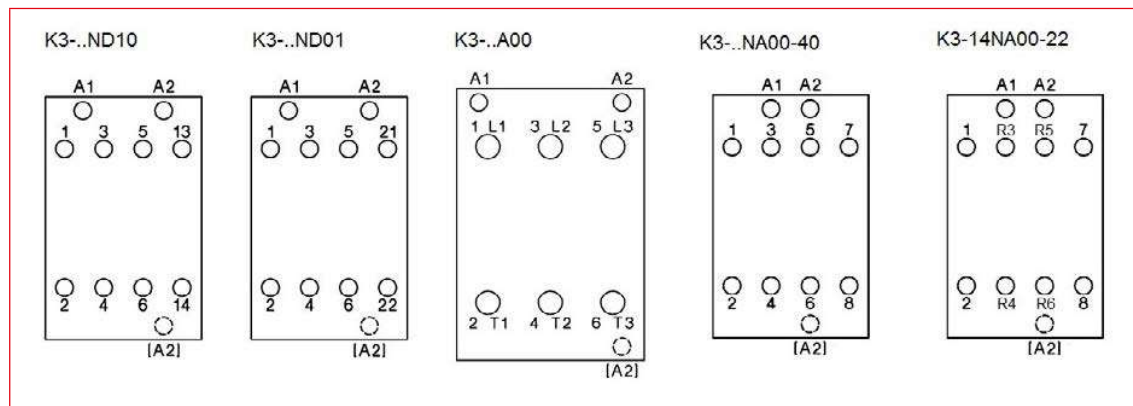

























Leistungsschütze LA, Baugröße 3, 4 - 18,5kW

Lage der Anschlussklemmen





BEZEICHNUNG	TYPE NR.	VERFÜGBAR	STORE	BEST. NR.
4kW / 10A AC3, 25A AC-1, 3-polig				
4kW/10A AC3, 1 Schließer, 24VAC	K3-10ND10			LA301010N
4kW/10A AC3, 1 Schließer, 24VDC	K3-10ND10=			LA301015N
4kW/10A AC3, 1 Öffner, 24VAC	K3-10ND01			LA301020N
4kW/10A AC3, 25A AC1, 1 Schließer, 48VAC	K3-10ND10			LA301011N
4kW/10A AC3, 25A AC1, 1 Schließer, 110VAC	K3-10ND10			LA301012N
4kW, 1 Schließer, 230VAC, 10A AC3	K3-10ND10			LA301013N
4kW, 1 Schließer, 400VAC, 10A AC3,	K3-10ND10			LA301014N
4kW/10A AC3, 1 Öffner, 230VAC	K3-10ND01			LA301023N
4kW/10A AC3, 1 Öffner, 400VAC	K3-10ND01			LA301024N
4kW/10A AC3, 1 Öffner, 24VDC	K3-10ND01=			LA301025N
4kW / 10A AC3, 25A AC-1, 4-polig				
4kW/10A AC3, 230VAC	K3-10NA00-40			LA301043N
5,5kW / 14A AC-3, 25A AC-1, 3-polig				
5,5kW/14A AC3, 25A AC1, 3-polig, 1 Schließer 24VAC	K3-14ND10			LA301410N
5,5kW/14A AC3, 25A AC1, 3-polig, 1 Schließer, 48VAC	K3-14ND10			LA301411N
5,5kW/14A AC3, 25A AC1, 3-polig, 1 Öffner, 24VAC	K3-14ND01			LA301420N
5,5kW/14A AC3, 25A AC1, 3-polig, 1 Öffner, 110VAC	K3-14ND01			LA301422N
5,5kW/14A AC3, 25A AC1, 3-polig, 1 Schließer, 24VDC	K3-14ND10=			LA301415N
5,5kW/14A AC3, 25A AC1, 3-polig, 1 Schließer, 220VDC	K3-14ND10=			LA301418N
5,5kW/14A AC3, 25A AC1, 3-polig, 1 Öffner, 24VDC	K3-14ND01=			LA301425N
5,5kW/14A AC3, 25A AC1, 3-polig, 1 Schließer, 110VAC	K3-14ND10			LA301412N
5,5kW/14A AC3, 25A AC1, 3-polig, 1 Schließer 230VAC	K3-14ND10			LA301413N
5,5kW/14A AC3, 25A AC1, 3-polig, 1 Öffner, 230VAC	K3-14ND01			LA301423N
5,5kW/14A AC3, 25A AC1, 3-polig, 1 Schließer, 400VAC	K3-14ND10			LA301414N
5,5kW/14A AC3, 25A AC1, 3-polig, 1 Öffner, 400VAC	K3-14ND01			LA301424N
5,5kW / 14A AC-3, 25A AC-1, 4-polig				
5,5 kW/14A AC3,25A AC1, 230VAC	K3-14NA00-40			LA301443N
5,5kW/14A AC3, 25A AC1, 2 Schließer + 2 Öffner, 230VAC	K3-14NA00-22			LA3014C3N
7,5kW / 18A AC-3, 32A AC-1, 3-polig				
7,5kW/18A AC3, 32A AC1, 3-polig, 1 Schließer, 24VAC	K3-18ND10			LA301810N
7,5kW/18A AC3, 32A AC1, 3-polig, 1 Schließer, 24VDC	K3-18ND10=			LA301815N
7,5kW/18A AC3, 32A AC1, 3-polig, 1 Schließer, 48VDC	K3-18ND10=			LA301816N
7,5kW/18A AC3, 32A AC1, 3-polig, 1 Öffner, 24VAC	K3-18ND01			LA301820N
7,5kW/18A AC3, 32A AC1, 3-polig, 1 Öffner, 24VDC	K3-18ND01=			LA301825N
7,5kW/18A AC3, 32A AC1, 3-polig, 1 Schließer, 48VAC	K3-18ND10			LA301811N
7,5kW/18A AC3, 32A AC1, 3-polig, 1 Schließer, 110VAC	K3-18ND10			LA301812N
7,5kW/18A AC3, 32A AC1, 3-polig, 1 Schließer, 230VAC	K3-18ND10			LA301813N

Leistungsschütze LA, Baugröße 3, 4 - 18,5kW

BEZEICHNUNG	TYPE NR.	VERFÜGBAR	STORE	BEST. NR.
7,5kW / 18A AC-3, 32A AC-1, 3-polig				
7,5kW/18A AC3, 32A AC1, 3-polig, 1 Öffner, 230VAC	K3-18ND01			LA301823N
7,5kW/18A AC3, 32A AC1, 3-polig, 1 Schließer, 415VAC	K3-18ND10			LA301814N
7,5kW / 18A AC-3, 32A AC-1, 4-polig				
7,5 kW, 4-polig, 18A AC3, 32A AC1, 230VAC	K3-18NA00-40			LA301843N
11kW / 22A AC-3, 32A AC-1, 3-polig				
11kW/22A AC3, 32A AC1, 3-polig, 1 Schließer, 24VAC	K3-22ND10			LA302210N
11kW/22A AC3, 32A AC1, 3-polig, 1 Schließer, 24VDC	K3-22ND10=			LA302215N
11kW/22A AC3, 32A AC1, 3-polig, 1 Schließer, 48VDC	K3-22ND10=			LA302216N
11kW/22A AC3, 32A AC1, 3-polig, 1 Öffner, 24VDC	K3-22ND01=			LA302225N
11kW/22A AC3, 32A AC1, 3-polig, 1 Schließer, 48VAC	K3-22ND10			LA302211N
11kW/22A AC3, 32A AC1, 3-polig, 1 Schließer, 110VAC	K3-22ND10			LA302212N
11kW/22A AC3, 32A AC1, 3-polig, 1 Schließer, 230VAC	K3-22ND10			LA302213N
11kW/22A AC3, 32A AC1, 3-polig, 1 Öffner, 230VAC	K3-22ND01			LA302223N
11kW/22A AC3, 32A AC1, 3-polig, 1 Schließer, 400VAC	K3-22ND10			LA302214N
11kW/22A AC3, 32A AC1, 3-polig, 1 Öffner, 400VAC	K3-22ND01			LA302224N
11kW / 22A AC-3, 32A AC-1, 4-polig				
11kW/22A AC3, 32A AC1, 4-polig, 230VAC	K3-22NA00-40			LA302243N
11kW / 24A AC-3, 50A AC-1, 3-polig				
11kW/24A AC3, 50A AC1, 3-polig, 24VAC	K3-24A00			LA302430
11kW/24A AC3, 50A AC1, 3-polig, 48VDC	K3-24A00=			LA302436
11kW/24A AC3, 50A AC1, 3-polig, 24VDC	K3-24A00=			LA302435
11kW/24A AC3, 50A AC1, 3-polig, 48VAC	K3-24A00			LA302431
11kW/24A AC3, 50A AC1, 3-polig, 110VAC	K3-24A00			LA302432
11kW/24A AC3, 50A AC1, 3-polig, 230VAC	K3-24A00			LA302433
15kW / 32A AC-3, 65A AC-1, 3-polig				
15kW/32A AC3, 65A AC1, 3-polig, 24VAC	K3-32A00			LA303230
15kW/32A AC3, 65A AC1, 3-polig, 24VDC	K3-32A00=			LA303235
15kW/32A AC3, 65A AC1, 3-polig, 48VAC	K3-32A00			LA303231
15kW/32A AC3, 65A AC1, 3-polig, 110VAC	K3-32A00			LA303232
15kW/32A AC3, 65A AC1, 3-polig, 230VAC	K3-32A00			LA303233
15kW/32A AC3, 65A AC1, 3-polig, 400VAC	K3-32A00			LA303234
15kW/32A AC3, 65A AC1, 3-polig, 48VDC	K3-32A00=			LA303236
18,5kW / 40A AC-3, 80A AC-1, 3-polig				
18,5kW/40A AC3, 80A AC1, 3-polig, 24VAC	K3-40A00			LA304030
18,5kW/40A AC3, 80A AC1, 3-polig, 48VAC	K3-40A00			LA304031
18,5kW/40A AC3, 80A AC1, 3-polig, 110VAC	K3-40A00			LA304032
18,5kW/40A AC3, 80A AC1, 3-polig, 230VAC	K3-40A00			LA304033
18,5kW/40A AC3, 80A AC1, 3-polig, 400VAC	K3-40A00			LA304034
18,5kW/40A AC3, 80A AC1, 3-polig, 24VDC	K3-40A00=			LA304035
Hilfskontakte				
frontseitig 1 Schließer, 3A (230V, AC-15) für K2, K3-07 bis K3-115, K4	HN10			LA190100
frontseitig 1 Öffner, 3A (230V, AC-15) für K2, K3-07 bis K3-115, K4	HN01			LA190101
frontseitig 1 Öffner, 6A (230V, AC-15) für K2, K3-07 bis K3-115, K4	HA01			LA190135
frontseitig 1 Schließer, 6A (230V, AC-15) für K2, K3-07 bis K3-115, K4	HA10			LA190137
frontseitig 1 Früh-Schließer, 3A (230V, AC-15) für K2, K3-07 bis K3-115, K4	HN10U			LA190138
frontseitig 1 Spät-Öffner, 3A (230V, AC-15) für K2, K3-07 bis K3-115, K4	HN01U			LA190139

 Lieferung üblicherweise innerhalb 1 Woche!

 **Best. Nr. blau:** Lagerware, d.h. üblicherweise versandbereit am Bestelltag!  Zusätzliche Abholverfügbarkeit in jedem Schrack Store!