

Verteilersystem Modul 2000 – Allgemeine Informationen



SCHRACK-INFO

- Modular aufgebauter Stahlblechverteiler in stabiler Abkantkonstruktion
- Aufputz, Unterputz und Maskenverteiler individuell ausführbar
- Optimaler Putzausgleich durch superflachen Unterputzrahmen
- 300mm und 400mm tiefe Aufputz-Verteiler ab 3A/39 Modulhöhen
- Geräteeinsatz nachträglich einsetz- und schwenkbar
- Frontplatten aus Stahlblech oder Kunststoff mit Schnellmontageriegel als Abdeckung für 45mm Schutzschalt- und Reiheneinbaugeräte
- Bestückung mit Stahlblech oder Kunststoff-Frontplatte möglich
- 6 verschiedene Montagetiefen für DIN-Schienen möglich
- Türen wahlweise rechts oder links anschlagbar
- Als Zählerverteiler in ein-, zwei- oder dreireihiger Ausführung mit bis zu 15 Zählerplätzen einsetzbar
- Aufklappbare Mauerwanne in versteifter Ausführung mit Putzdeckel aus Karton zum nachträglichen Verteilereinbau geeignet
- Kabeleinführungsschlitz bei Aufputz-Verteiler inkl. Abdeckung serienmäßig (bei 2-5ZB und 21-33MH ist die Einführung einseitig, ab 39MH oben und unten) jede Einführung mit Moosgummi geschlossen
- Türe standardmäßig mit Drehriegel; mit 61005 Schloss oder Halbzylinder gegen Aufpreis lieferbar
- Doppeltüre für 4 und 5 Zählerplatzbreite Verteiler
- Türen größer 3T-28 auf Wunsch mit Dreipunkt-Stangenverschluss inkl. Schwenkhebel
- Schrittmaß: 1 Modulhöhe = 46mm
1 Zählerbreite (1ZB) AP-/UP-Rahmen=380mm, MV=330mm
2 Zählerbreiten (2ZB) AP-/UP-Rahmen=590mm, MV=540mm
3 Zählerbreiten (3ZB) AP-/UP-Rahmen=810mm, MV=760mm
4 Zählerbreiten (4ZB) AP-/UP-Rahmen=1030mm, MV=980mm
5 Zählerbreiten (5ZB) AP-/UP-Rahmen=1230mm, MV=1180mm
- Geräte/Teilungseinheit TE=17,8mm
- Normzählertafel: H=370 B=210 T=15mm
- Stromkreisverzeichnis ist beige packt

Technische Daten

Verteiler:	Phosphatierter, kunststoffpulverbeschichteter Stahlblechverteiler geprüft und zertifiziert nach EN 62208:2011 und EN 60529:1991 Schutzklasse I für TT/TN und IT Netzform geeignet, schutzisoliert nach ÖVE-IM 12
Bemessungsspannung:	230/400V/50Hz
Bemessungsisolationsspannung:	400VAC
Schutzleiteranschluss:	Schweißbolzen M6, I _p = 3,6 · 10 ⁶ A ² s
Umgebungstemperatur:	-5 bis +40°C
Relative Luftfeuchte:	50% bei 40°C
Max. zulässiges Einbaugewicht:	Einsatz: 150kg Standmontage Einsatz: 80kg Wandmontage (ohne zusätzliche Maßnahmen)
Türe:	10kg
Schutzart:	IP20 nach ÖVE-EN 60529 mit und ohne Türe IP54 IK08 nach EN 50102 EMV Umgebung I
Farbe:	Aufputz und Maskenverteiler: RAL 7035, Unterputz: RAL 9016

Verteilersystem Modul 2000 – Montage



1. Einsatz zusammenbauen

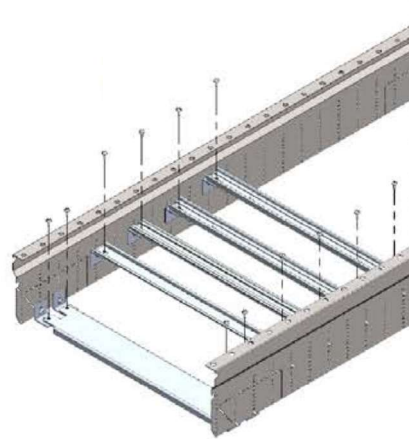
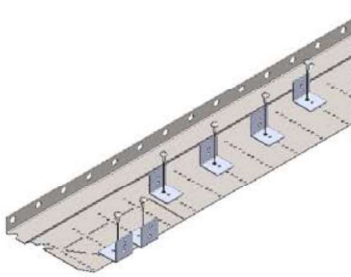

2. Mauerwanne zusammenbauen

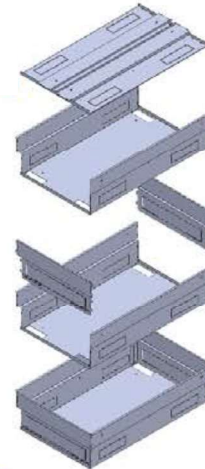

3. Einsatz einbauen

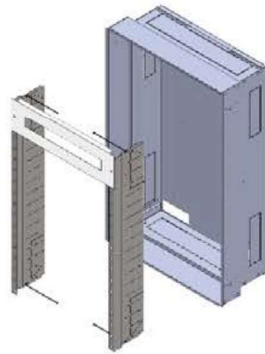

4. Rahmen einbauen

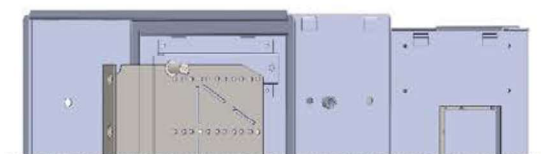
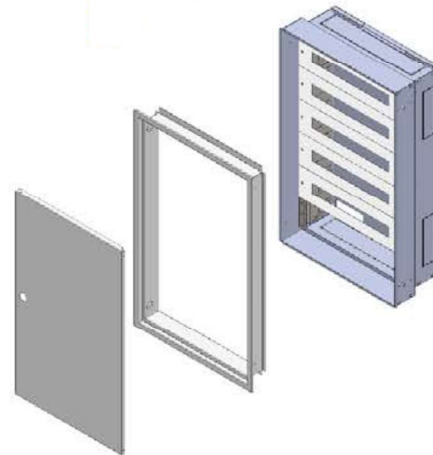

5. Kunststoffdrehriegelschloss

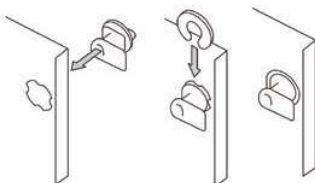

6. Schlossblech-Montagezylinder z.B. 61005 Sperre

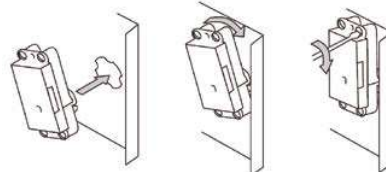

7. Halbzylinderschloss mit Schwenkhebel bei

AP-Rahmen IP20
300mm tief IL036....
400mm tief IL009....

AP-Rahmen IP54

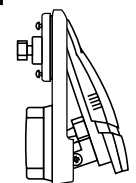

Verteilersystem Modul 2000 – Typenschlüsselauflbau

Zählerbausätze 1-15 Pl.
8 (9) Moduleinheiten je
Zählerreihe

 8 (9)
bei 1 Zählerplatz

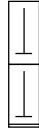
 16 (18)

 24 (27)

Frontplatten
Stahlblech oder Kunststoff

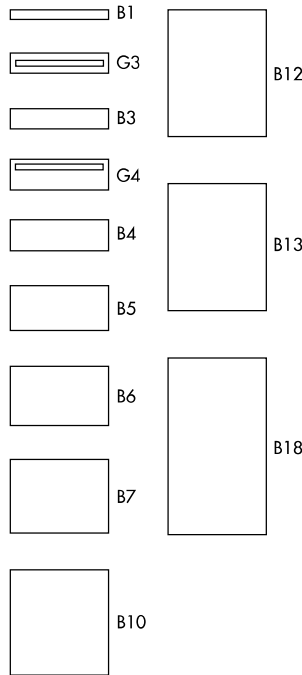

VZ-Stecktüren für
diverse EVU-Sperren

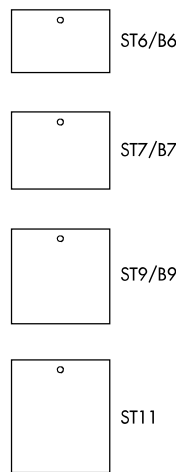

Gerätetragschienen und
Montageplatten Stahlblech

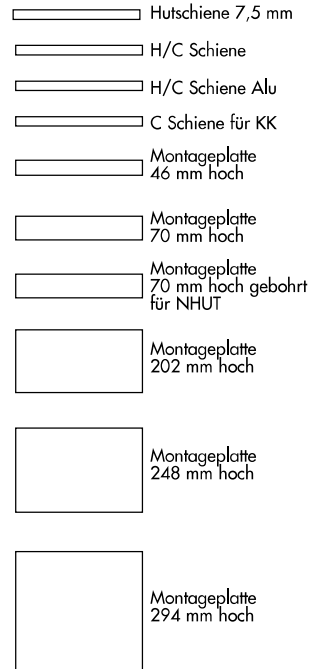

Bestellbeispiel:

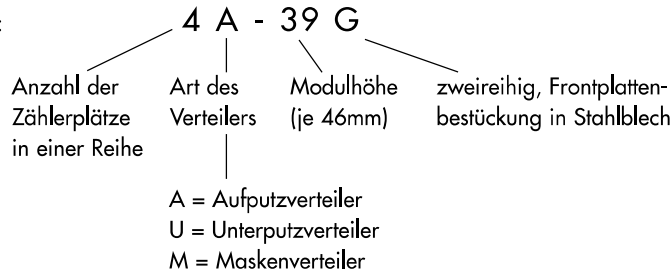

IL162439BS













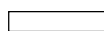



Verteilersystem Modul 2000 – Frontplattenbestückung

EVU-Zählerverteiler						Installationsverteiler	
mit einer Zählerreihe 370 x 210		mit zwei Zählerreihen 370 x 210		mit drei Zählerreihen 370 x 210		durchgehend mit Frontplatten bestückt	
Frontplatten		Frontplatten		Frontplatten		Frontplatten	
Stahlblech	Kunststoff	Stahlblech	Kunststoff	Stahlblech	Kunststoff	Stahlblech	Kunststoff
E	F	G	H	M	O	K	L

Abmessungen: + 0 ... -5mm. Andere Ausführungen auf Anfrage.

 Höhe Zählerplatz
(entspricht bei 8 Modulhöhen - 368 mm,
bei 9 Modulhöhen - 414 mm pro Reihe)

Verteilersystem Modul 2000 – Farbcode für Frontplatten Stahlblech – K und Kunststoff – L

	.B1	46 mm	Blindfrontplatte		.B7/ST7	322 mm	Blindfrontplatte / Stecktüre
	.B3	138 mm	Blindfrontplatte		.B9/ST9	414 mm	Blindfrontplatte / Stecktüre
	.G3	138 mm	Gerätefrontplatte		.B10	460 mm	Blindfrontplatte
	.B4	184 mm	Blindfrontplatte		ST11	506 mm	Stecktüre
	.G4	184 mm	Gerätefrontplatte		.B12	552 mm	Blindfrontplatte
	.B5	230 mm	Blindfrontplatte		.B13	598 mm	Blindfrontplatte (nur in Kunststoff)
	.B6/ST6	276 mm	Blindfrontplatte / Stecktüre		.B18	828 mm	Blindfrontplatte

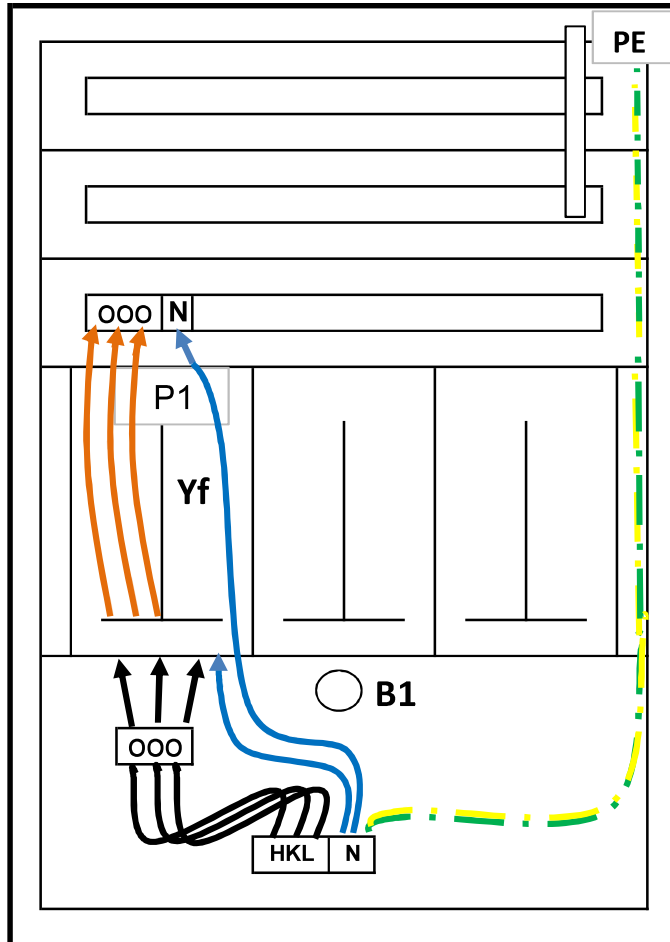
 Verteiler Energie Burgenland-Verdrahtungsschema

In Absprache mit Energie Burgenland auch Ausführung mit NH-Trenner, D02, Tytan oder NH-Unterteilen möglich.

Vorzähleraufbauten unterhalb der Stecktüre mit B1-Sperre.

Konfigurationsbeispiel IL168342BS, 3A-42M, 9 Zählerplätze, Energie Burgenland

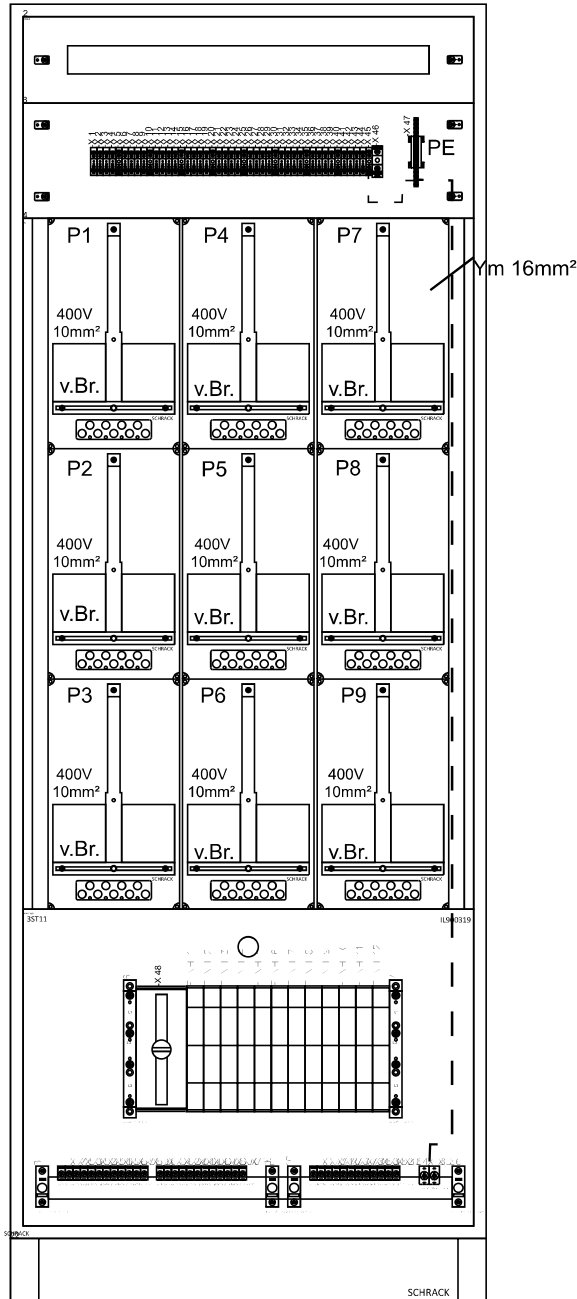

IL036342-F	Aufputz-Rahmen 3A-42 mit Türe, RW und SH	1 Stk.
IL439342-F	Zählerverteiler Einsatz 3-42M, 9 ZP Netz Burgenland	1 Stk.
IU001916--	Halbzylinder 61005 zu Schwenkebel IL900205-F	1 Stk.
IL091300--	Socket-Frontrahmen für AP-Verteiler Breite 3	2 Stk.
IL091130--	Socket-Seitenteile 300mm (1 Paar)	1 Stk.
IL900380--	BEWAG-Schloss mit gerader Sperrlasche	1 Stk.

IL439342-F Set beinhaltet:

IL046042-G	Einsatzwange 3S 42/150 tief	2 Stk.
IL056304-H	Blindfrontplatte 3B4 Stahlblech	1 Stk.
IL051303-H	Gerätefrontblende 3G3 Stahlblech	1 Stk.
IL080306-F	SHC-Schiene 3H/C	4 Stk.
IL080307--	Alu H/C Schiene 3H/C	2 Stk.
IL186322-A	Zählerwanne 3-reihig, 9 Zählerplätze, 24MH	1 Stk.
IL900319--	VZ-Stecktüre ohne Schloss 3ST11	1 Stk.
IL900026-F	Montagewinkel Metall	1 VE
IL902254--	Platte grau „Celanex“	8 Stk.
IL902257--	Riegel grau „Celanex“	8 Stk.

Einbauteile lt. Konfiguration (Vorzahlerteil unter Stecktüre montiert!)

IL900301--	Adapter M2000 VZ-CU-Aufbauten kurz	2 Stk.
IL900302--	Adapter M2000 VZ-CU-Aufbauten lang	2 Stk.
IG714043--	Gewindeplättchen M6 (VE=100 Stück)	12 Stk.
SI015000--	Universal Sammelschienenenträger 3-polig	2 Stk.
SI015730--	Endabdeckung passend zu SI015000--, SI014950--	2 Stk.
SI016010--	PE/N-Träger 1-polig einzeln montierbar	4 Stk.
SI012430--	Anschlussklemmplatte 3-polig, 35-120mm²	2 Stk.
IS504823--	D02-Reitersicherungssockel E18 ohne Abdeckung	9 Stk.
IS504824--	D02-Streifenabd. 27mm 3-polig	7 Stk.
IS504825--	D02-Streifenabd. 36mm + Verbr. 3-polig	1 Stk.
IS504826--	D02-Streifenabd. 54mm + Verbr. 3-polig	1 Stk.
SI310060--	D02-Schraubkappe Kunststoff	27 Stk.
IS505069--	Kupfer-Sammelschiene, blank 379A (450A)	2 Stk.
SI012870--	Universal Leiteranschlußklemme 16-70mm²/5mm	2 Stk.
SI012850--	Universal Leiteranschlußklemme 4-35mm²/5mm	2 Stk.
SI012840--	Universal Leiteranschlußklemme 1,5-16mm²/5mm	27 Stk.
IK623001--	Endhalter für IK6-Klemmen, Type KD 3	2 Stk.
IK600010--	Schraubklemme 10mm², Type AVK 10 grau	27 Stk.
IK601010--	Schraubklemme 10mm², Type AVK 10 blau	9 Stk.
IK622010--	Schraubklemme 10mm², Type AVK 10 grün/gelb	9 Stk.
IK622035-A	Schraubklemme 10mm², Type AVK 35 grün/gelb	2 Stk.
IK697040--	Markierungsetiketten DY 5 bedruckt von „1-50“	1 Stk.
IK697041--	Markierungsetiketten DY 5 bedruckt von „51-100“	1 Stk.

*** ohne Sicherungseinsätze ***

Bestellhinweis: Typenschlüssel **IL 168 3 42 B S**

Verteilerart
IL172 .. Installationsverteiler
IL160 .. Zählerverteiler AP
IL164 .. Zählerverteiler UP

Verteilerbreite/Zählerbreite

Moduleinheit Höhe























S = Stahlblechausführung
K = Kunststoffausführung

Rahmentype
A = Aufputzrahmen
U = Unterputzrahmen
M = Maskenrahmen (ohne Türe)
Regionale Zählerverteiler: N = Netz NÖ/EVN
W = Burgenland
B = Energie Burgenland

Verteilersystem Modul 2000 – Burgenland

Zählerverteiler - Frontblende Stahlblech

Seite
10

Modul-Einheiten	1 ZÄHLERPLATZ PRO REIHE 1, 2, 3 ZP – 13 TE pro Frontplatte	2 ZÄHLERPLÄTZE PRO REIHE 2, 4, 6 ZP – 21 TE pro Frontplatte	3 ZÄHLERPLÄTZE PRO REIHE 3, 6, 9 ZP – 33 TE pro Frontplatte	Höhe (mm)*
1 NZR 138 mm	1A-18 E IL160118BS 756,10 1U-18 E IL164118BS 814,20 1M-18 E IL153118BS 547,70	2A-18 E IL160218BS 850,90 2U-18 E IL164218BS 870,00 2M-18 E IL153218BS 558,80	3A-18 E IL160318BS 1.006,00 3U-18 E IL164318BS 1.035,50 3M-18 E IL153318BS 661,40	T = 250 T = 250 T = 200
	18 322 mm  AP-Rahmen ILO06118 370,40 UP-Rahmen ILO08118 232,20 MV-Rahmen ILO78118 162,00 ZV-Einsatz IL419118 345,50 Mauerwanne ILO69118 236,50 Rückwand ILO42118 40,24	 AP-Rahmen ILO06218 457,30 UP-Rahmen ILO08218 275,80 MV-Rahmen ILO78218 162,00 ZV-Einsatz IL419218 345,40 Mauerwanne ILO69218 248,80 Rückwand ILO42218 48,20	 AP-Rahmen ILO06318 518,30 UP-Rahmen ILO08318 322,80 MV-Rahmen ILO78318 173,30 ZV-Einsatz IL419318 423,10 Mauerwanne ILO69318 289,30 Rückwand ILO42318 65,02	A = 915 A = 915 M = 875 E = 830 P = 885
2 NZR 276 mm	1A-21 E IL160121BS 926,00 1U-21 E IL164121BS 931,30 1M-21 E IL153121BS 609,20	2A-21 E IL160221BS 998,50 2U-21 E IL164221BS 1.009,00 2M-21 E IL153221BS 619,20	3A-21 E IL160321BS 1.154,00 3U-21 E IL164321BS 1.155,00 3M-21 E IL153321BS 729,70	T = 250 T = 250 T = 200
	21 322 mm  AP-Rahmen ILO06121 490,30 UP-Rahmen ILO08121 294,70 MV-Rahmen ILO78121 173,50 ZV-Einsatz IL419121 388,10 Mauerwanne ILO69121 248,50 Rückwand ILO42121 47,57	 AP-Rahmen ILO06221 556,00 UP-Rahmen ILO08221 330,90 MV-Rahmen ILO78221 176,70 ZV-Einsatz IL419221 389,50 Mauerwanne ILO69221 288,20 Rückwand ILO42221 52,95	 AP-Rahmen ILO06321 608,70 UP-Rahmen ILO08321 362,00 MV-Rahmen ILO78321 184,80 ZV-Einsatz IL419321 473,20 Mauerwanne ILO69321 319,70 Rückwand ILO42321 71,68	A = 1055 A = 1055 M = 1010 E = 970 P = 1025
3 NZR 414 mm	1A-24 E IL160124BS 1.015,00 1U-24 E IL164124BS 1.087,00 1M-24 E IL153124BS 664,10	2A-24 E IL160224BS 1.119,00 2U-24 E IL164224BS 1.111,00 2M-24 E IL153224BS 677,40	3A-24 E IL160324BS 1.302,00 3U-24 E IL164324BS 1.258,00 3M-24 E IL153324BS 796,40	T = 250 T = 250 T = 200
	24 322 mm  AP-Rahmen ILO06124 533,10 UP-Rahmen ILO08124 372,00 MV-Rahmen ILO78124 182,20 ZV-Einsatz IL419124 429,50 Mauerwanne ILO69124 285,60 Rückwand ILO42124 52,43	 AP-Rahmen ILO06224 626,60 UP-Rahmen ILO08224 381,90 MV-Rahmen ILO78224 185,40 ZV-Einsatz IL419224 432,40 Mauerwanne ILO69224 296,60 Rückwand ILO42224 59,58	 AP-Rahmen ILO06324 699,20 UP-Rahmen ILO08324 405,00 MV-Rahmen ILO78324 193,50 ZV-Einsatz IL419324 522,10 Mauerwanne ILO69324 330,50 Rückwand ILO42324 80,77	A = 1195 A = 1195 M = 1150 E = 1105 P = 1165
4 NZR 598 mm	1A-28 E IL160128BS 1.161,00 1U-28 E IL164128BS 1.184,00 1M-28 E IL153128BS 744,30	2A-28 E IL160228BS 1.289,00 2U-28 E IL164228BS 1.250,00 2M-28 E IL153228BS 766,10	3A-28 E IL160328BS 1.448,00 3U-28 E IL164328BS 1.389,00 3M-28 E IL153328BS 897,20	T = 250 T = 250 T = 200
	28 322 mm  AP-Rahmen ILO06128 617,00 UP-Rahmen ILO08128 401,60 MV-Rahmen ILO78128 200,50 ZV-Einsatz IL419128 484,70 Mauerwanne ILO69128 298,00 Rückwand ILO42128 59,11	 AP-Rahmen ILO06228 727,10 UP-Rahmen ILO08228 426,30 MV-Rahmen ILO78228 203,70 ZV-Einsatz IL419228 492,70 Mauerwanne ILO69228 331,10 Rückwand ILO42228 69,66	 AP-Rahmen ILO06328 763,10 UP-Rahmen ILO08328 441,00 MV-Rahmen ILO78328 211,80 ZV-Einsatz IL419328 591,30 Mauerwanne ILO69328 357,10 Rückwand ILO42328 94,06	A = 1380 A = 1380 M = 1335 E = 1290 P = 1350
1 NZR 138 mm		2A-28 G IL162228BS 1.454,00 2U-28 G IL166228BS 1.415,00 2M-28 G IL154228BS 930,80	3A-28 G IL162328BS 1.703,00 3U-28 G IL166328BS 1.644,00 3M-28 G IL154328BS 1.151,00	T = 250 T = 250 T = 200
	28 414 mm  AP-Rahmen ILO06228 727,10 UP-Rahmen ILO08228 426,30 MV-Rahmen ILO78228 203,70 ZV-Einsatz IL429228 657,40 Mauerwanne ILO69228 331,10 Rückwand ILO42228 69,66	 AP-Rahmen ILO06328 763,10 UP-Rahmen ILO08328 441,00 MV-Rahmen ILO78328 211,80 ZV-Einsatz IL429328 845,50 Mauerwanne ILO69328 357,10 Rückwand ILO42328 94,06	A = 1380 A = 1380 M = 1335 E = 1290 P = 1350	
6 NZR 828 mm		2A-33 E IL160233BS 1.453,00 2U-33 E IL164233BS 1.413,00 2M-33 E IL153233BS 878,30	3A-33 E IL160333BS 1.654,00 3U-33 E IL164333BS 1.591,00 3M-33 E IL153333BS 1.031,00	T = 250 T = 250 T = 200
	33 322 mm  AP-Rahmen ILO06233 791,00 UP-Rahmen ILO08233 487,10 MV-Rahmen ILO78233 215,90 ZV-Einsatz IL419233 573,00 Mauerwanne ILO69233 353,20 Rückwand ILO42233 89,36	 AP-Rahmen ILO06333 847,10 UP-Rahmen ILO08333 500,00 MV-Rahmen ILO78333 224,00 ZV-Einsatz IL419333 680,70 Mauerwanne ILO69333 410,20 Rückwand ILO42333 125,80	A = 1605 A = 1605 M = 1565 E = 1520 P = 1575	
2 NZR 276 mm		2A-33 G IL162233BS 1.620,00 2U-33 G IL166233BS 1.580,00 2M-33 G IL154233BS 1.044,00	3A-33 G IL162333BS 2.007,00 3U-33 G IL166333BS 1.944,00 3M-33 G IL154333BS 1.384,00	T = 250 T = 250 T = 200
	33 506 mm  AP-Rahmen ILO06233 791,00 UP-Rahmen ILO08233 487,10 MV-Rahmen ILO78233 215,90 ZV-Einsatz IL429233 739,20 Mauerwanne ILO69233 353,20 Rückwand ILO42233 89,36	 AP-Rahmen ILO06333 847,10 UP-Rahmen ILO08333 500,00 MV-Rahmen ILO78333 224,00 ZV-Einsatz IL429333 1.034,00 Mauerwanne ILO69333 410,20 Rückwand ILO42333 125,80	A = 1605 A = 1605 M = 1565 E = 1520 P = 1575	
8 NZR 1104 mm		2A-39 E IL160239BS 1.686,00 2U-39 E IL164239BS 1.639,00 2M-39 E IL153239BS 1.021,00	3A-39 E IL160339BS 1.899,00 3U-39 E IL164339BS 1.841,00 3M-39 E IL153339BS 1.184,00	T = 250 T = 250 T = 200
	39 322 mm  AP-Rahmen ILO06239 896,50 UP-Rahmen ILO08239 561,70 MV-Rahmen ILO78239 231,00 ZV-Einsatz IL419239 679,90 Mauerwanne ILO69239 397,30 Rückwand ILO42239 109,60	 AP-Rahmen ILO06339 954,00 UP-Rahmen ILO08339 592,40 MV-Rahmen ILO78339 239,10 ZV-Einsatz IL419339 799,70 Mauerwanne ILO69339 449,30 Rückwand ILO42339 144,90	A = 1885 A = 1885 M = 1855 E = 1795 P = 1885	
4 NZR 552 mm		2A-39 G IL162239BS 1.849,00 2U-39 G IL166239BS 1.802,00 2M-39 G IL154239BS 1.183,00	3A-39 G IL162339BS 2.249,00 3U-39 G IL166339BS 2.192,00 3M-39 G IL154339BS 1.534,00	T = 250 T = 250 T = 200
	39 506 mm  AP-Rahmen ILO06239 896,50 UP-Rahmen ILO08239 561,70 MV-Rahmen ILO78239 231,00 ZV-Einsatz IL429239 842,50 Mauerwanne ILO69239 397,30 Rückwand ILO42239 109,60	 AP-Rahmen ILO06339 954,00 UP-Rahmen ILO08339 592,40 MV-Rahmen ILO78339 239,10 ZV-Einsatz IL429339 1.150,00 Mauerwanne ILO69339 449,30 Rückwand ILO42339 144,90	A = 1885 A = 1885 M = 1855 E = 1795 P = 1885	
Breite (mm)*	Außenmaß UP/AP = 380 Masken-Außenmaß = 330 Einsatz = 290 Putznische = 370	Außenmaß UP/AP = 590 Masken-Außenmaß = 540 Einsatz = 500 Putznische = 580	Außenmaß UP/AP = 810 Masken-Außenmaß = 760 Einsatz = 720 Putznische = 800	

*Toleranzen: + 0 E. – 3 mm, Mauerwammentiefe 250 mm

T = Tiefe, A = Außenmaß UP/AP, M = Masken-Außenmaß, E = Einsatz, P = Putznische

Zählerverteiler - Frontblende Stahlblech

Modul-Einheiten	4 ZÄHLERPLÄTZE PRO REIHE 4, 8, 12 ZP – 45 TE pro Frontplatte			5 ZÄHLERPLÄTZE PRO REIHE 5, 10, 15 ZP – 57 TE pro Frontplatte			Höhe (mm)*
1 NZR 138 mm 18 322 mm		4A-18 E IL160418BS 1.211,00 4U-18 E IL164418BS 1.241,00 4M-18 E IL153418BS 770,30 AP-Rahmen IL006418 625,20 UP-Rahmen IL008418 405,00 MV-Rahmen IL078418 184,20 ZV-Einsatz IL419418 506,90 Mauerwanne IL069418 329,30 Rückwand IL042418 79,18					T = 250 T = 250 T = 200 A = 915 A = 915 M = 875 E = 830 P = 885
2 NZR 276 mm 21 322 mm		4A-21 E IL160421BS 1.397,00 4U-21 E IL164421BS 1.375,00 4M-21 E IL153421BS 845,80 AP-Rahmen IL006421 746,80 UP-Rahmen IL008421 478,70 MV-Rahmen IL078421 195,60 ZV-Einsatz IL419421 562,40 Mauerwanne IL069421 333,40 Rückwand IL042421 87,79				T = 250 T = 250 T = 200 A = 1055 A = 1055 M = 1010 E = 970 P = 1025	
3 NZR 414 mm 24 322 mm		4A-24 E IL160424BS 1.571,00 4U-24 E IL164424BS 1.506,00 4M-24 E IL153424BS 923,10 AP-Rahmen IL006424 852,00 UP-Rahmen IL008424 543,00 MV-Rahmen IL078424 204,30 ZV-Einsatz IL419424 616,70 Mauerwanne IL069424 346,50 Rückwand IL042424 102,10		5A-24 E IL160524BS 2.259,00 5U-24 E IL164524BS 2.123,00 5M-24 E IL153524BS 1.480,00 AP-Rahmen IL006524 1.083,00 UP-Rahmen IL008524 695,90 MV-Rahmen IL078524 303,60 ZV-Einsatz IL419524 1.027,00 Mauerwanne IL069524 399,80 Rückwand IL042524 149,10		T = 250 T = 250 T = 200 A = 1195 A = 1195 M = 1150 E = 1105 P = 1165	
4 NZR 598 mm 28 322 mm		4A-28 E IL160428BS 1.787,00 4U-28 E IL164428BS 1.671,00 4M-28 E IL153428BS 1.038,00 AP-Rahmen IL006428 971,90 UP-Rahmen IL008428 593,50 MV-Rahmen IL078428 222,60 ZV-Einsatz IL419428 696,50 Mauerwanne IL069428 381,20 Rückwand IL042428 119,00		5A-28 E IL160528BS 2.457,00 5U-28 E IL164528BS 2.375,00 5M-28 E IL153528BS 1.622,00 AP-Rahmen IL006528 1.157,00 UP-Rahmen IL008528 741,80 MV-Rahmen IL078528 321,90 ZV-Einsatz IL419528 1.117,00 Mauerwanne IL069528 516,10 Rückwand IL042528 183,20		T = 250 T = 250 T = 200 A = 1380 A = 1380 M = 1335 E = 1290 P = 1350	
1 NZR 138 mm 28 414 mm		4A-28 G IL162428BS 2.108,00 4U-28 G IL166428BS 1.992,00 4M-28 G IL154428BS 1.359,00 AP-Rahmen IL006428 971,90 UP-Rahmen IL008428 593,50 MV-Rahmen IL078428 222,60 ZV-Einsatz IL429428 1.017,00 Mauerwanne IL069428 381,20 Rückwand IL042428 119,00		5A-28 G IL162528BS 2.740,00 5U-28 G IL166528BS 2.658,00 5M-28 G IL154528BS 1.905,00 AP-Rahmen IL006528 1.157,00 UP-Rahmen IL008528 741,80 MV-Rahmen IL078528 321,90 ZV-Einsatz IL429528 1.400,00 Mauerwanne IL069528 516,10 Rückwand IL042528 183,20		T = 250 T = 250 T = 200 A = 1380 A = 1380 M = 1335 E = 1290 P = 1350	
6 NZR 828 mm 33 322 mm		4A-33 E IL160433BS 2.000,00 4U-33 E IL164433BS 1.866,00 4M-33 E IL153433BS 1.179,00 AP-Rahmen IL006433 1.055,00 UP-Rahmen IL008433 639,00 MV-Rahmen IL078433 234,80 ZV-Einsatz IL419433 791,60 Mauerwanne IL069433 435,00 Rückwand IL042433 153,00		5A-33 E IL160533BS 2.683,00 5U-33 E IL164533BS 2.585,00 5M-33 E IL153533BS 1.774,00 AP-Rahmen IL006533 1.243,00 UP-Rahmen IL008533 818,30 MV-Rahmen IL078533 334,10 ZV-Einsatz IL419533 1.232,00 Mauerwanne IL069533 535,10 Rückwand IL042533 208,20		T = 250 T = 250 T = 200 A = 1605 A = 1605 M = 1565 E = 1520 P = 1575	
2 NZR 276 mm 33 506 mm		4A-33 G IL162433BS 2.394,00 4U-33 G IL166433BS 2.260,00 4M-33 G IL154433BS 1.574,00 AP-Rahmen IL006433 1.055,00 UP-Rahmen IL008433 639,00 MV-Rahmen IL078433 234,80 ZV-Einsatz IL429433 1.186,00 Mauerwanne IL069433 435,00 Rückwand IL042433 153,00		5A-33 G IL162533BS 2.940,00 5U-33 G IL166533BS 2.842,00 5M-33 G IL154533BS 2.031,00 AP-Rahmen IL006533 1.243,00 UP-Rahmen IL008533 818,30 MV-Rahmen IL078533 334,10 ZV-Einsatz IL429533 1.489,00 Mauerwanne IL069533 535,10 Rückwand IL042533 208,20		T = 250 T = 250 T = 200 A = 1605 A = 1605 M = 1565 E = 1520 P = 1575	
8 NZR 1104 mm 39 322 mm		4A-39 E IL160439BS 2.275,00 4U-39 E IL164439BS 2.178,00 4M-39 E IL153439BS 1.349,00 AP-Rahmen IL006439 1.176,00 UP-Rahmen IL008439 773,90 MV-Rahmen IL078439 249,90 ZV-Einsatz IL419439 921,30 Mauerwanne IL069439 482,90 Rückwand IL042439 177,40		5A-39 E IL160539BS 2.986,00 5U-39 E IL164539BS 2.879,00 5M-39 E IL153539BS 1.970,00 AP-Rahmen IL006539 1.366,00 UP-Rahmen IL008539 902,20 MV-Rahmen IL078539 349,20 ZV-Einsatz IL419539 1.382,00 Mauerwanne IL069539 594,60 Rückwand IL042539 238,40		T = 250 T = 250 T = 200 A = 1885 A = 1885 M = 1855 E = 1795 P = 1885	
4 NZR 552 mm 39 506 mm		4A-39 G IL162439BS 2.669,00 4U-39 G IL166439BS 2.573,00 4M-39 G IL154439BS 1.743,00 AP-Rahmen IL006439 1.176,00 UP-Rahmen IL008439 773,90 MV-Rahmen IL078439 249,90 ZV-Einsatz IL429439 1.316,00 Mauerwanne IL069439 482,90 Rückwand IL042439 177,40		5A-39 G IL162539BS 3.239,00 5U-39 G IL166539BS 3.132,00 5M-39 G IL154539BS 2.223,00 AP-Rahmen IL006539 1.366,00 UP-Rahmen IL008539 902,20 MV-Rahmen IL078539 349,20 ZV-Einsatz IL429539 1.635,00 Mauerwanne IL069539 594,60 Rückwand IL042539 238,40		T = 250 T = 250 T = 200 A = 1885 A = 1885 M = 1855 E = 1795 P = 1885	
Breite (mm)*	Außenmaß UP/AP = 1030 Masken-Außenmaß = 980 Einsatz = 940 Putznische = 1020			Außenmaß UP/AP = 1230 Masken-Außenmaß = 1180 Einsatz = 1140 Putznische = 1220			











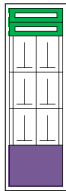

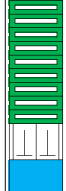
T = Tiefe, A = Außenmaß UP/AP, M = Masken-Außenmaß, E = Einsatz, P = Putznische

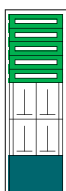
*) Toleranzen: + 0 E. - 3 mm, Mauerwammentiefe 750 mm

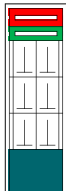
Verteilersystem Modul 2000 – Burgenland

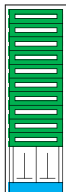
Zählerverteiler - Frontblende Stahlblech

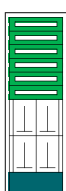
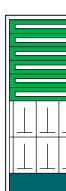
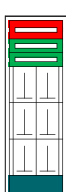





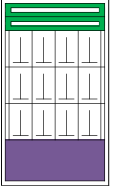

Seite
12

Modul-Einheiten	1 ZÄHLERPLATZ PRO REIHE 1, 2, 3 ZP – 13 TE pro Frontplatte	2 ZÄHLERPLÄTZE PRO REIHE 2, 4, 6 ZP – 21 TE pro Frontplatte	3 ZÄHLERPLÄTZE PRO REIHE 3, 6, 9 ZP – 33 TE pro Frontplatte	Höhe (mm)*
2 NZR 276 mm 39 414 mm	 2A-39 M IL168239BS 1.900,00 2U-39 M IL170239BS 1.853,00 2M-39 M IL122239BS 1.235,00 AP-Rahmen IL006239 896,50 UP-Rahmen IL008239 561,70 MV-Rahmen IL078239 231,00 ZV-Einsatz IL439239 893,90 Mauerwanne IL069239 397,30 Rückwand IL042239 109,60	 3A-39 M IL168339BS 2.250,00 3U-39 M IL170339BS 2.193,00 3M-39 M IL122339BS 1.535,00 AP-Rahmen IL006339 954,00 UP-Rahmen IL008339 592,40 MV-Rahmen IL078339 239,10 ZV-Einsatz IL439339 1.151,00 Mauerwanne IL069339 449,30 Rückwand IL042339 144,90	T = 250 T = 250 T = 200 A = 1885 A = 1885 M = 1855 E = 1795 P = 1885	
9 NZR 1242 mm 42 322 mm	 2A-42 E IL160242BS 1.848,00 2U-42 E IL164242BS 1.777,00 2M-42 E IL153242BS 1.127,00 AP-Rahmen IL006242 998,30 UP-Rahmen IL008242 635,70 MV-Rahmen IL078242 277,00 ZV-Einsatz IL419242 729,70 Mauerwanne IL069242 411,60 Rückwand IL042242 119,90	 3A-42 E IL160342BS 2.037,00 3U-42 E IL164342BS 1.950,00 3M-42 E IL153342BS 1.264,00 AP-Rahmen IL006342 1.059,00 UP-Rahmen IL008342 653,80 MV-Rahmen IL078342 285,10 ZV-Einsatz IL419342 827,70 Mauerwanne IL069342 468,00 Rückwand IL042342 150,70	T = 250 T = 250 T = 200 A = 2025 A = 2025 M = 1995 E = 1935 P = 1995	
5 NZR 690 mm 42 506 mm	 2A-42 G IL162242BS 1.994,00 2U-42 G IL166242BS 1.923,00 2M-42 G IL154242BS 1.272,00 AP-Rahmen IL006242 998,30 UP-Rahmen IL008242 635,70 MV-Rahmen IL078242 277,00 ZV-Einsatz IL429242 875,50 Mauerwanne IL069242 411,60 Rückwand IL042242 119,90	 3A-42 G IL162342BS 2.399,00 3U-42 G IL166342BS 2.311,00 3M-42 G IL154342BS 1.625,00 AP-Rahmen IL006342 1.059,00 UP-Rahmen IL008342 653,80 MV-Rahmen IL078342 285,10 ZV-Einsatz IL429342 1.189,00 Mauerwanne IL069342 468,00 Rückwand IL042342 150,70	T = 250 T = 250 T = 200 A = 2025 A = 2025 M = 1995 E = 1935 P = 1995	
2 NZR 322 mm 42 506 mm	 2A-42 M IL168242BS 2.023,00 2U-42 M IL170242BS 1.952,00 2M-42 M IL122242BS 1.301,00 AP-Rahmen IL006242 998,30 UP-Rahmen IL008242 635,70 MV-Rahmen IL078242 277,00 ZV-Einsatz IL439242 904,40 Mauerwanne IL069242 411,60 Rückwand IL042242 119,90	 3A-42 M IL168342BS 2.479,00 3U-42 M IL170342BS 2.391,00 3M-42 M IL122342BS 1.705,00 AP-Rahmen IL006342 1.059,00 UP-Rahmen IL008342 653,80 MV-Rahmen IL078342 285,10 ZV-Einsatz IL439342 1.269,00 Mauerwanne IL069342 468,00 Rückwand IL042342 150,70	T = 250 T = 250 T = 200 A = 2025 A = 2025 M = 1995 E = 1935 P = 1995	
10 NZR 1380 mm 45 322 mm	 2A-45 E IL160245BS 1.981,00 2U-45 E IL164245BS 1.994,00 2M-45 E IL153245BS 1.238,00 AP-Rahmen IL006245 1.065,00 UP-Rahmen IL008245 703,20 MV-Rahmen IL078245 321,90 ZV-Einsatz IL419245 799,30 Mauerwanne IL069245 491,00 Rückwand IL042245 116,60	 3A-45 E IL160345BS 2.328,00 3U-45 E IL164345BS 2.220,00 3M-45 E IL153345BS 1.425,00 AP-Rahmen IL006345 1.233,00 UP-Rahmen IL008345 741,80 MV-Rahmen IL078345 330,00 ZV-Einsatz IL419345 931,10 Mauerwanne IL069345 547,40 Rückwand IL042345 164,10	T = 250 T = 250 T = 200 A = 2160 A = 2160 M = 2130 E = 2070 P = 2130	
6 NZR 828 mm 45 506 mm	 2A-45 G IL162245BS 2.127,00 2U-45 G IL166245BS 2.139,00 2M-45 G IL154245BS 1.384,00 AP-Rahmen IL006245 1.065,00 UP-Rahmen IL008245 703,20 MV-Rahmen IL078245 321,90 ZV-Einsatz IL429245 945,10 Mauerwanne IL069245 491,00 Rückwand IL042245 116,60	 3A-45 G IL162345BS 2.661,00 3U-45 G IL166345BS 2.553,00 3M-45 G IL154345BS 1.758,00 AP-Rahmen IL006345 1.233,00 UP-Rahmen IL008345 741,80 MV-Rahmen IL078345 330,00 ZV-Einsatz IL429345 1.264,00 Mauerwanne IL069345 547,40 Rückwand IL042345 164,10	T = 250 T = 250 T = 200 A = 2160 A = 2160 M = 2130 E = 2070 P = 2130	
3 NZR 460 mm 45 506 mm	 2A-45 M IL168245BS 2.156,00 2U-45 M IL170245BS 2.168,00 2M-45 M IL122245BS 1.413,00 AP-Rahmen IL006245 1.065,00 UP-Rahmen IL008245 703,20 MV-Rahmen IL078245 321,90 ZV-Einsatz IL439245 974,00 Mauerwanne IL069245 491,00 Rückwand IL042245 116,60	 3A-45 M IL168345BS 2.725,00 3U-45 M IL170345BS 2.617,00 3M-45 M IL122345BS 1.822,00 AP-Rahmen IL006345 1.233,00 UP-Rahmen IL008345 741,80 MV-Rahmen IL078345 330,00 ZV-Einsatz IL439345 1.328,00 Mauerwanne IL069345 547,40 Rückwand IL042345 164,10	T = 250 T = 250 T = 200 A = 2160 A = 2160 M = 2130 E = 2070 P = 2130	
Breite (mm)*	Außenmaß UP/AP = 380 Masken-Außenmaß = 330 Einsatz = 290 Putznische = 370	Außenmaß UP/AP = 590 Masken-Außenmaß = 540 Einsatz = 500 Putznische = 580	Außenmaß UP/AP = 810 Masken-Außenmaß = 760 Einsatz = 720 Putznische = 800	

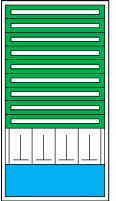
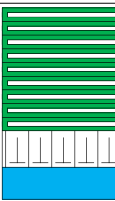
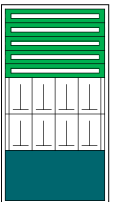
*1) Toleranzen: + 0 E, - 3 mm, Mauerwammentiefe 250 mm

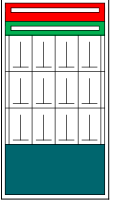
T = Tiefe, A = Außenmaß UP/AP, M = Masken-Außenmaß, E = Einsatz, P = Putznische

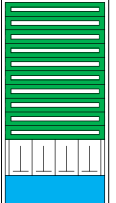
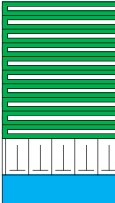
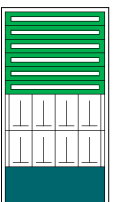
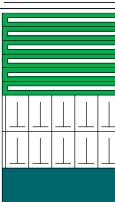
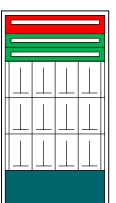
Zählerverteiler - Frontblende Stahlblech

Modul-Einheiten	4 ZÄHLERPLÄTZE PRO REIHE 4, 8, 12 ZP – 45 TE pro Frontplatte	5 ZÄHLERPLÄTZE PRO REIHE 5, 10, 15 ZP – 57 TE pro Frontplatte	Höhe (mm)*																																																						
2 NZR 276 mm 39 414 mm	 <table border="0"> <tr><td>4A-39 M</td><td>IL168439BS</td><td>2.764,00</td></tr> <tr><td>4U-39 M</td><td>IL170439BS</td><td>2.668,00</td></tr> <tr><td>4M-39 M</td><td>IL122439BS</td><td>1.838,00</td></tr> <tr><td>AP-Rahmen</td><td>ILO06439</td><td>1.176,00</td></tr> <tr><td>UP-Rahmen</td><td>ILO08439</td><td>773,90</td></tr> <tr><td>MV-Rahmen</td><td>ILO78439</td><td>249,90</td></tr> <tr><td>ZV-Einsatz</td><td>IL439439</td><td>1.411,00</td></tr> <tr><td>Mauerwanne</td><td>ILO69439</td><td>482,90</td></tr> <tr><td>Rückwand</td><td>ILO42439</td><td>177,40</td></tr> </table>	4A-39 M	IL168439BS	2.764,00	4U-39 M	IL170439BS	2.668,00	4M-39 M	IL122439BS	1.838,00	AP-Rahmen	ILO06439	1.176,00	UP-Rahmen	ILO08439	773,90	MV-Rahmen	ILO78439	249,90	ZV-Einsatz	IL439439	1.411,00	Mauerwanne	ILO69439	482,90	Rückwand	ILO42439	177,40	 <table border="0"> <tr><td>5A-39 M</td><td>IL168539BS</td><td>3.347,00</td></tr> <tr><td>5U-39 M</td><td>IL170539BS</td><td>3.240,00</td></tr> <tr><td>5M-39 M</td><td>IL122539BS</td><td>2.331,00</td></tr> <tr><td>AP-Rahmen</td><td>ILO06539</td><td>1.366,00</td></tr> <tr><td>UP-Rahmen</td><td>ILO08539</td><td>902,20</td></tr> <tr><td>MV-Rahmen</td><td>ILO78539</td><td>349,20</td></tr> <tr><td>ZV-Einsatz</td><td>IL439539</td><td>1.743,00</td></tr> <tr><td>Mauerwanne</td><td>ILO69539</td><td>594,60</td></tr> <tr><td>Rückwand</td><td>ILO42539</td><td>238,40</td></tr> </table>	5A-39 M	IL168539BS	3.347,00	5U-39 M	IL170539BS	3.240,00	5M-39 M	IL122539BS	2.331,00	AP-Rahmen	ILO06539	1.366,00	UP-Rahmen	ILO08539	902,20	MV-Rahmen	ILO78539	349,20	ZV-Einsatz	IL439539	1.743,00	Mauerwanne	ILO69539	594,60	Rückwand	ILO42539	238,40	T = 250 T = 250 T = 200 A = 1885 A = 1885 M = 1855 E = 1795 P = 1885
4A-39 M	IL168439BS	2.764,00																																																							
4U-39 M	IL170439BS	2.668,00																																																							
4M-39 M	IL122439BS	1.838,00																																																							
AP-Rahmen	ILO06439	1.176,00																																																							
UP-Rahmen	ILO08439	773,90																																																							
MV-Rahmen	ILO78439	249,90																																																							
ZV-Einsatz	IL439439	1.411,00																																																							
Mauerwanne	ILO69439	482,90																																																							
Rückwand	ILO42439	177,40																																																							
5A-39 M	IL168539BS	3.347,00																																																							
5U-39 M	IL170539BS	3.240,00																																																							
5M-39 M	IL122539BS	2.331,00																																																							
AP-Rahmen	ILO06539	1.366,00																																																							
UP-Rahmen	ILO08539	902,20																																																							
MV-Rahmen	ILO78539	349,20																																																							
ZV-Einsatz	IL439539	1.743,00																																																							
Mauerwanne	ILO69539	594,60																																																							
Rückwand	ILO42539	238,40																																																							
9 NZR 1242 mm 42 322 mm	 <table border="0"> <tr><td>4A-42 E</td><td>IL160442BS</td><td>2.402,00</td></tr> <tr><td>4U-42 E</td><td>IL164442BS</td><td>2.373,00</td></tr> <tr><td>4M-42 E</td><td>IL153442BS</td><td>1.462,00</td></tr> <tr><td>AP-Rahmen</td><td>ILO06442</td><td>1.236,00</td></tr> <tr><td>UP-Rahmen</td><td>ILO08442</td><td>861,00</td></tr> <tr><td>MV-Rahmen</td><td>ILO78442</td><td>295,90</td></tr> <tr><td>ZV-Einsatz</td><td>IL419442</td><td>982,50</td></tr> <tr><td>Mauerwanne</td><td>ILO69442</td><td>529,60</td></tr> <tr><td>Rückwand</td><td>ILO42442</td><td>183,40</td></tr> </table>	4A-42 E	IL160442BS	2.402,00	4U-42 E	IL164442BS	2.373,00	4M-42 E	IL153442BS	1.462,00	AP-Rahmen	ILO06442	1.236,00	UP-Rahmen	ILO08442	861,00	MV-Rahmen	ILO78442	295,90	ZV-Einsatz	IL419442	982,50	Mauerwanne	ILO69442	529,60	Rückwand	ILO42442	183,40	 <table border="0"> <tr><td>5A-42 E</td><td>IL160542BS</td><td>3.193,00</td></tr> <tr><td>5U-42 E</td><td>IL164542BS</td><td>3.114,00</td></tr> <tr><td>5M-42 E</td><td>IL153542BS</td><td>2.101,00</td></tr> <tr><td>AP-Rahmen</td><td>ILO06542</td><td>1.487,00</td></tr> <tr><td>UP-Rahmen</td><td>ILO08542</td><td>988,30</td></tr> <tr><td>MV-Rahmen</td><td>ILO78542</td><td>395,20</td></tr> <tr><td>ZV-Einsatz</td><td>IL419542</td><td>1.453,00</td></tr> <tr><td>Mauerwanne</td><td>ILO69542</td><td>672,90</td></tr> <tr><td>Rückwand</td><td>ILO42542</td><td>252,50</td></tr> </table>	5A-42 E	IL160542BS	3.193,00	5U-42 E	IL164542BS	3.114,00	5M-42 E	IL153542BS	2.101,00	AP-Rahmen	ILO06542	1.487,00	UP-Rahmen	ILO08542	988,30	MV-Rahmen	ILO78542	395,20	ZV-Einsatz	IL419542	1.453,00	Mauerwanne	ILO69542	672,90	Rückwand	ILO42542	252,50	T = 250 T = 250 T = 200 A = 2025 A = 2025 M = 1995 E = 1935 P = 1995
4A-42 E	IL160442BS	2.402,00																																																							
4U-42 E	IL164442BS	2.373,00																																																							
4M-42 E	IL153442BS	1.462,00																																																							
AP-Rahmen	ILO06442	1.236,00																																																							
UP-Rahmen	ILO08442	861,00																																																							
MV-Rahmen	ILO78442	295,90																																																							
ZV-Einsatz	IL419442	982,50																																																							
Mauerwanne	ILO69442	529,60																																																							
Rückwand	ILO42442	183,40																																																							
5A-42 E	IL160542BS	3.193,00																																																							
5U-42 E	IL164542BS	3.114,00																																																							
5M-42 E	IL153542BS	2.101,00																																																							
AP-Rahmen	ILO06542	1.487,00																																																							
UP-Rahmen	ILO08542	988,30																																																							
MV-Rahmen	ILO78542	395,20																																																							
ZV-Einsatz	IL419542	1.453,00																																																							
Mauerwanne	ILO69542	672,90																																																							
Rückwand	ILO42542	252,50																																																							
5 NZR 690 mm 42 506 mm	 <table border="0"> <tr><td>4A-42 G</td><td>IL162442BS</td><td>2.780,00</td></tr> <tr><td>4U-42 G</td><td>IL166442BS</td><td>2.752,00</td></tr> <tr><td>4M-42 G</td><td>IL154442BS</td><td>1.840,00</td></tr> <tr><td>AP-Rahmen</td><td>ILO06442</td><td>1.236,00</td></tr> <tr><td>UP-Rahmen</td><td>ILO08442</td><td>861,00</td></tr> <tr><td>MV-Rahmen</td><td>ILO78442</td><td>295,90</td></tr> <tr><td>ZV-Einsatz</td><td>IL429442</td><td>1.361,00</td></tr> <tr><td>Mauerwanne</td><td>ILO69442</td><td>529,60</td></tr> <tr><td>Rückwand</td><td>ILO42442</td><td>183,40</td></tr> </table>	4A-42 G	IL162442BS	2.780,00	4U-42 G	IL166442BS	2.752,00	4M-42 G	IL154442BS	1.840,00	AP-Rahmen	ILO06442	1.236,00	UP-Rahmen	ILO08442	861,00	MV-Rahmen	ILO78442	295,90	ZV-Einsatz	IL429442	1.361,00	Mauerwanne	ILO69442	529,60	Rückwand	ILO42442	183,40	 <table border="0"> <tr><td>5A-42 G</td><td>IL162542BS</td><td>3.429,00</td></tr> <tr><td>5U-42 G</td><td>IL166542BS</td><td>3.350,00</td></tr> <tr><td>5M-42 G</td><td>IL154542BS</td><td>2.337,00</td></tr> <tr><td>AP-Rahmen</td><td>ILO06542</td><td>1.487,00</td></tr> <tr><td>UP-Rahmen</td><td>ILO08542</td><td>988,30</td></tr> <tr><td>MV-Rahmen</td><td>ILO78542</td><td>395,20</td></tr> <tr><td>ZV-Einsatz</td><td>IL429542</td><td>1.689,00</td></tr> <tr><td>Mauerwanne</td><td>ILO69542</td><td>672,90</td></tr> <tr><td>Rückwand</td><td>ILO42542</td><td>252,50</td></tr> </table>	5A-42 G	IL162542BS	3.429,00	5U-42 G	IL166542BS	3.350,00	5M-42 G	IL154542BS	2.337,00	AP-Rahmen	ILO06542	1.487,00	UP-Rahmen	ILO08542	988,30	MV-Rahmen	ILO78542	395,20	ZV-Einsatz	IL429542	1.689,00	Mauerwanne	ILO69542	672,90	Rückwand	ILO42542	252,50	T = 250 T = 250 T = 200 A = 2025 A = 2025 M = 1995 E = 1935 P = 1995
4A-42 G	IL162442BS	2.780,00																																																							
4U-42 G	IL166442BS	2.752,00																																																							
4M-42 G	IL154442BS	1.840,00																																																							
AP-Rahmen	ILO06442	1.236,00																																																							
UP-Rahmen	ILO08442	861,00																																																							
MV-Rahmen	ILO78442	295,90																																																							
ZV-Einsatz	IL429442	1.361,00																																																							
Mauerwanne	ILO69442	529,60																																																							
Rückwand	ILO42442	183,40																																																							
5A-42 G	IL162542BS	3.429,00																																																							
5U-42 G	IL166542BS	3.350,00																																																							
5M-42 G	IL154542BS	2.337,00																																																							
AP-Rahmen	ILO06542	1.487,00																																																							
UP-Rahmen	ILO08542	988,30																																																							
MV-Rahmen	ILO78542	395,20																																																							
ZV-Einsatz	IL429542	1.689,00																																																							
Mauerwanne	ILO69542	672,90																																																							
Rückwand	ILO42542	252,50																																																							
2 NZR 322 mm 42 506 mm	 <table border="0"> <tr><td>4A-42 M</td><td>IL168442BS</td><td>2.915,00</td></tr> <tr><td>4U-42 M</td><td>IL170442BS</td><td>2.887,00</td></tr> <tr><td>4M-42 M</td><td>IL122442BS</td><td>1.975,00</td></tr> <tr><td>AP-Rahmen</td><td>ILO06442</td><td>1.236,00</td></tr> <tr><td>UP-Rahmen</td><td>ILO08442</td><td>861,00</td></tr> <tr><td>MV-Rahmen</td><td>ILO78442</td><td>295,90</td></tr> <tr><td>ZV-Einsatz</td><td>IL439442</td><td>1.496,00</td></tr> <tr><td>Mauerwanne</td><td>ILO69442</td><td>529,60</td></tr> <tr><td>Rückwand</td><td>ILO42442</td><td>183,40</td></tr> </table>	4A-42 M	IL168442BS	2.915,00	4U-42 M	IL170442BS	2.887,00	4M-42 M	IL122442BS	1.975,00	AP-Rahmen	ILO06442	1.236,00	UP-Rahmen	ILO08442	861,00	MV-Rahmen	ILO78442	295,90	ZV-Einsatz	IL439442	1.496,00	Mauerwanne	ILO69442	529,60	Rückwand	ILO42442	183,40	 <table border="0"> <tr><td>5A-42 M</td><td>IL168542BS</td><td>3.474,00</td></tr> <tr><td>5U-42 M</td><td>IL170542BS</td><td>3.395,00</td></tr> <tr><td>5M-42 M</td><td>IL122542BS</td><td>2.382,00</td></tr> <tr><td>AP-Rahmen</td><td>ILO06542</td><td>1.487,00</td></tr> <tr><td>UP-Rahmen</td><td>ILO08542</td><td>988,30</td></tr> <tr><td>MV-Rahmen</td><td>ILO78542</td><td>395,20</td></tr> <tr><td>ZV-Einsatz</td><td>IL439542</td><td>1.734,00</td></tr> <tr><td>Mauerwanne</td><td>ILO69542</td><td>672,90</td></tr> <tr><td>Rückwand</td><td>ILO42542</td><td>252,50</td></tr> </table>	5A-42 M	IL168542BS	3.474,00	5U-42 M	IL170542BS	3.395,00	5M-42 M	IL122542BS	2.382,00	AP-Rahmen	ILO06542	1.487,00	UP-Rahmen	ILO08542	988,30	MV-Rahmen	ILO78542	395,20	ZV-Einsatz	IL439542	1.734,00	Mauerwanne	ILO69542	672,90	Rückwand	ILO42542	252,50	T = 250 T = 250 T = 200 A = 2025 A = 2025 M = 1995 E = 1935 P = 1995
4A-42 M	IL168442BS	2.915,00																																																							
4U-42 M	IL170442BS	2.887,00																																																							
4M-42 M	IL122442BS	1.975,00																																																							
AP-Rahmen	ILO06442	1.236,00																																																							
UP-Rahmen	ILO08442	861,00																																																							
MV-Rahmen	ILO78442	295,90																																																							
ZV-Einsatz	IL439442	1.496,00																																																							
Mauerwanne	ILO69442	529,60																																																							
Rückwand	ILO42442	183,40																																																							
5A-42 M	IL168542BS	3.474,00																																																							
5U-42 M	IL170542BS	3.395,00																																																							
5M-42 M	IL122542BS	2.382,00																																																							
AP-Rahmen	ILO06542	1.487,00																																																							
UP-Rahmen	ILO08542	988,30																																																							
MV-Rahmen	ILO78542	395,20																																																							
ZV-Einsatz	IL439542	1.734,00																																																							
Mauerwanne	ILO69542	672,90																																																							
Rückwand	ILO42542	252,50																																																							
10 NZR 1380 mm 45 322 mm	 <table border="0"> <tr><td>4A-45 E</td><td>IL160445BS</td><td>2.560,00</td></tr> <tr><td>4U-45 E</td><td>IL164445BS</td><td>2.653,00</td></tr> <tr><td>4M-45 E</td><td>IL153445BS</td><td>1.607,00</td></tr> <tr><td>AP-Rahmen</td><td>ILO06445</td><td>1.294,00</td></tr> <tr><td>UP-Rahmen</td><td>ILO08445</td><td>955,60</td></tr> <tr><td>MV-Rahmen</td><td>ILO78445</td><td>340,80</td></tr> <tr><td>ZV-Einsatz</td><td>IL419445</td><td>1.064,00</td></tr> <tr><td>Mauerwanne</td><td>ILO69445</td><td>633,50</td></tr> <tr><td>Rückwand</td><td>ILO42445</td><td>202,00</td></tr> </table>	4A-45 E	IL160445BS	2.560,00	4U-45 E	IL164445BS	2.653,00	4M-45 E	IL153445BS	1.607,00	AP-Rahmen	ILO06445	1.294,00	UP-Rahmen	ILO08445	955,60	MV-Rahmen	ILO78445	340,80	ZV-Einsatz	IL419445	1.064,00	Mauerwanne	ILO69445	633,50	Rückwand	ILO42445	202,00	 <table border="0"> <tr><td>5A-45 E</td><td>IL160545BS</td><td>3.442,00</td></tr> <tr><td>5U-45 E</td><td>IL164545BS</td><td>3.453,00</td></tr> <tr><td>5M-45 E</td><td>IL153545BS</td><td>2.252,00</td></tr> <tr><td>AP-Rahmen</td><td>ILO06545</td><td>1.630,00</td></tr> <tr><td>UP-Rahmen</td><td>ILO08545</td><td>1.117,00</td></tr> <tr><td>MV-Rahmen</td><td>ILO78545</td><td>440,10</td></tr> <tr><td>ZV-Einsatz</td><td>IL419545</td><td>1.544,00</td></tr> <tr><td>Mauerwanne</td><td>ILO69545</td><td>792,00</td></tr> <tr><td>Rückwand</td><td>ILO42545</td><td>267,70</td></tr> </table>	5A-45 E	IL160545BS	3.442,00	5U-45 E	IL164545BS	3.453,00	5M-45 E	IL153545BS	2.252,00	AP-Rahmen	ILO06545	1.630,00	UP-Rahmen	ILO08545	1.117,00	MV-Rahmen	ILO78545	440,10	ZV-Einsatz	IL419545	1.544,00	Mauerwanne	ILO69545	792,00	Rückwand	ILO42545	267,70	T = 250 T = 250 T = 200 A = 2160 A = 2160 M = 2130 E = 2070 P = 2130
4A-45 E	IL160445BS	2.560,00																																																							
4U-45 E	IL164445BS	2.653,00																																																							
4M-45 E	IL153445BS	1.607,00																																																							
AP-Rahmen	ILO06445	1.294,00																																																							
UP-Rahmen	ILO08445	955,60																																																							
MV-Rahmen	ILO78445	340,80																																																							
ZV-Einsatz	IL419445	1.064,00																																																							
Mauerwanne	ILO69445	633,50																																																							
Rückwand	ILO42445	202,00																																																							
5A-45 E	IL160545BS	3.442,00																																																							
5U-45 E	IL164545BS	3.453,00																																																							
5M-45 E	IL153545BS	2.252,00																																																							
AP-Rahmen	ILO06545	1.630,00																																																							
UP-Rahmen	ILO08545	1.117,00																																																							
MV-Rahmen	ILO78545	440,10																																																							
ZV-Einsatz	IL419545	1.544,00																																																							
Mauerwanne	ILO69545	792,00																																																							
Rückwand	ILO42545	267,70																																																							
6 NZR 828 mm 45 506 mm	 <table border="0"> <tr><td>4A-45 G</td><td>IL162445BS</td><td>2.954,00</td></tr> <tr><td>4U-45 G</td><td>IL166445BS</td><td>3.047,00</td></tr> <tr><td>4M-45 G</td><td>IL154445BS</td><td>2.001,00</td></tr> <tr><td>AP-Rahmen</td><td>ILO06445</td><td>1.294,00</td></tr> <tr><td>UP-Rahmen</td><td>ILO08445</td><td>955,60</td></tr> <tr><td>MV-Rahmen</td><td>ILO78445</td><td>340,80</td></tr> <tr><td>ZV-Einsatz</td><td>IL429445</td><td>1.458,00</td></tr> <tr><td>Mauerwanne</td><td>ILO69445</td><td>633,50</td></tr> <tr><td>Rückwand</td><td>ILO42445</td><td>202,00</td></tr> </table>	4A-45 G	IL162445BS	2.954,00	4U-45 G	IL166445BS	3.047,00	4M-45 G	IL154445BS	2.001,00	AP-Rahmen	ILO06445	1.294,00	UP-Rahmen	ILO08445	955,60	MV-Rahmen	ILO78445	340,80	ZV-Einsatz	IL429445	1.458,00	Mauerwanne	ILO69445	633,50	Rückwand	ILO42445	202,00	 <table border="0"> <tr><td>5A-45 G</td><td>IL162545BS</td><td>3.678,00</td></tr> <tr><td>5U-45 G</td><td>IL166545BS</td><td>3.689,00</td></tr> <tr><td>5M-45 G</td><td>IL154545BS</td><td>2.488,00</td></tr> <tr><td>AP-Rahmen</td><td>ILO06545</td><td>1.630,00</td></tr> <tr><td>UP-Rahmen</td><td>ILO08545</td><td>1.117,00</td></tr> <tr><td>MV-Rahmen</td><td>ILO78545</td><td>440,10</td></tr> <tr><td>ZV-Einsatz</td><td>IL429545</td><td>1.780,00</td></tr> <tr><td>Mauerwanne</td><td>ILO69545</td><td>792,00</td></tr> <tr><td>Rückwand</td><td>ILO42545</td><td>267,70</td></tr> </table>	5A-45 G	IL162545BS	3.678,00	5U-45 G	IL166545BS	3.689,00	5M-45 G	IL154545BS	2.488,00	AP-Rahmen	ILO06545	1.630,00	UP-Rahmen	ILO08545	1.117,00	MV-Rahmen	ILO78545	440,10	ZV-Einsatz	IL429545	1.780,00	Mauerwanne	ILO69545	792,00	Rückwand	ILO42545	267,70	T = 250 T = 250 T = 200 A = 2160 A = 2160 M = 2130 E = 2070 P = 2130
4A-45 G	IL162445BS	2.954,00																																																							
4U-45 G	IL166445BS	3.047,00																																																							
4M-45 G	IL154445BS	2.001,00																																																							
AP-Rahmen	ILO06445	1.294,00																																																							
UP-Rahmen	ILO08445	955,60																																																							
MV-Rahmen	ILO78445	340,80																																																							
ZV-Einsatz	IL429445	1.458,00																																																							
Mauerwanne	ILO69445	633,50																																																							
Rückwand	ILO42445	202,00																																																							
5A-45 G	IL162545BS	3.678,00																																																							
5U-45 G	IL166545BS	3.689,00																																																							
5M-45 G	IL154545BS	2.488,00																																																							
AP-Rahmen	ILO06545	1.630,00																																																							
UP-Rahmen	ILO08545	1.117,00																																																							
MV-Rahmen	ILO78545	440,10																																																							
ZV-Einsatz	IL429545	1.780,00																																																							
Mauerwanne	ILO69545	792,00																																																							
Rückwand	ILO42545	267,70																																																							
3 NZR 460 mm 45 506 mm	 <table border="0"> <tr><td>4A-45 M</td><td>IL168445BS</td><td>3.089,00</td></tr> <tr><td>4U-45 M</td><td>IL170445BS</td><td>3.182,00</td></tr> <tr><td>4M-45 M</td><td>IL122445BS</td><td>2.136,00</td></tr> <tr><td>AP-Rahmen</td><td>ILO06445</td><td>1.294,00</td></tr> <tr><td>UP-Rahmen</td><td>ILO08445</td><td>955,60</td></tr> <tr><td>MV-Rahmen</td><td>ILO78445</td><td>340,80</td></tr> <tr><td>ZV-Einsatz</td><td>IL439445</td><td>1.593,00</td></tr> <tr><td>Mauerwanne</td><td>ILO69445</td><td>633,50</td></tr> <tr><td>Rückwand</td><td>ILO42445</td><td>202,00</td></tr> </table>	4A-45 M	IL168445BS	3.089,00	4U-45 M	IL170445BS	3.182,00	4M-45 M	IL122445BS	2.136,00	AP-Rahmen	ILO06445	1.294,00	UP-Rahmen	ILO08445	955,60	MV-Rahmen	ILO78445	340,80	ZV-Einsatz	IL439445	1.593,00	Mauerwanne	ILO69445	633,50	Rückwand	ILO42445	202,00	 <table border="0"> <tr><td>5A-45 M</td><td>IL168545BS</td><td>3.458,00</td></tr> <tr><td>5U-45 M</td><td>IL170545BS</td><td>3.469,00</td></tr> <tr><td>5M-45 M</td><td>IL122545BS</td><td>2.268,00</td></tr> <tr><td>AP-Rahmen</td><td>ILO06545</td><td>1.630,00</td></tr> <tr><td>UP-Rahmen</td><td>ILO08545</td><td>1.117,00</td></tr> <tr><td>MV-Rahmen</td><td>ILO78545</td><td>440,10</td></tr> <tr><td>ZV-Einsatz</td><td>IL439545</td><td>1.560,00</td></tr> <tr><td>Mauerwanne</td><td>ILO69545</td><td>792,00</td></tr> <tr><td>Rückwand</td><td>ILO42545</td><td>267,70</td></tr> </table>	5A-45 M	IL168545BS	3.458,00	5U-45 M	IL170545BS	3.469,00	5M-45 M	IL122545BS	2.268,00	AP-Rahmen	ILO06545	1.630,00	UP-Rahmen	ILO08545	1.117,00	MV-Rahmen	ILO78545	440,10	ZV-Einsatz	IL439545	1.560,00	Mauerwanne	ILO69545	792,00	Rückwand	ILO42545	267,70	T = 250 T = 250 T = 200 A = 2160 A = 2160 M = 2130 E = 2070 P = 2130
4A-45 M	IL168445BS	3.089,00																																																							
4U-45 M	IL170445BS	3.182,00																																																							
4M-45 M	IL122445BS	2.136,00																																																							
AP-Rahmen	ILO06445	1.294,00																																																							
UP-Rahmen	ILO08445	955,60																																																							
MV-Rahmen	ILO78445	340,80																																																							
ZV-Einsatz	IL439445	1.593,00																																																							
Mauerwanne	ILO69445	633,50																																																							
Rückwand	ILO42445	202,00																																																							
5A-45 M	IL168545BS	3.458,00																																																							
5U-45 M	IL170545BS	3.469,00																																																							
5M-45 M	IL122545BS	2.268,00																																																							
AP-Rahmen	ILO06545	1.630,00																																																							
UP-Rahmen	ILO08545	1.117,00																																																							
MV-Rahmen	ILO78545	440,10																																																							
ZV-Einsatz	IL439545	1.560,00																																																							
Mauerwanne	ILO69545	792,00																																																							
Rückwand	ILO42545	267,70																																																							
Breite (mm)*	Außenmaß UP/AP = 1030 Masken-Außenmaß = 980 Einsatz = 940 Putznische = 1020	Außenmaß UP/AP = 1230 Masken-Außenmaß = 1180 Einsatz = 1140 Putznische = 1220																																																							

T = Tiefe, A = Außenmaß UP/AP, M = Masken-Außenmaß, E = Einsatz, P = Putznische

*) Toleranzen: + 0 E. – 3 mm, Mauerwammentiefe 250 mm

Installationsverteiler - Frontblende Stahlblech

Modul- Einheiten	1 ZÄHLERBREITE 13 TE pro Frontplatte			2 ZÄHLERBREITE 21 TE pro Frontplatte			3 ZÄHLERBREITE 33 TE pro Frontplatte			Höhe (mm)*
4 IR	1A-12 K	IL177112AS	539,90	2A-12 K	IL177212AS	588,20	3A-12 K	IL177312AS	695,40	T = 180 T = 250 T = 200
	1U-12 K	IL172112US	616,90	2U-12 K	IL172212US	637,60	3U-12 K	IL172312US	771,60	
12	1M-12 K	IL172112MS	375,10	2M-12 K	IL172212MS	388,50	3M-12 K	IL172312MS	430,30	A = 640 A = 640 M = 595 E = 555 P = 630
	AP-Rahmen	IL006112-F	302,90	AP-Rahmen	IL006212-F	357,80	AP-Rahmen	IL006312-F	431,30	
	UP-Rahmen	IL308112-F	212,60	UP-Rahmen	IL308212-F	228,20	UP-Rahmen	IL308312-F	280,80	
	MV-Rahmen	IL078112-	154,90	MV-Rahmen	IL078212-	158,10	MV-Rahmen	IL078312-	166,20	
	IV-Einsatz	IL148112-	190,10	IV-Einsatz	IL148212-	196,20	IV-Einsatz	IL148312-	220,20	
	Mauerwanne	IL369112-F	214,20	Mauerwanne	IL369212-F	213,20	Mauerwanne	IL369312-F	270,60	
	Rückwand	IL042112-F	30,12	Rückwand	IL042212-F	34,15	Rückwand	IL042312-F	43,94	
6 IR	1A-18 K	IL172118AS	705,80	2A-18 K	IL172218AS	809,80	3A-18 K	IL172318AS	923,70	T = 250 T = 250 T = 200
	1U-18 K	IL172118US	763,90	2U-18 K	IL172218US	828,90	3U-18 K	IL172318US	952,50	
18	1M-18 K	IL172118MS	497,40	2M-18 K	IL172218MS	517,70	3M-18 K	IL172318MS	578,70	A = 915 A = 915 M = 875 E = 830 P = 885
	AP-Rahmen	IL006118-F	370,40	AP-Rahmen	IL006218-F	457,30	AP-Rahmen	IL006318-F	518,30	
	UP-Rahmen	IL308118-F	232,20	UP-Rahmen	IL308218-F	275,80	UP-Rahmen	IL308318-F	322,80	
	MV-Rahmen	IL078118-	162,00	MV-Rahmen	IL078218-	165,20	MV-Rahmen	IL078318-	173,30	
	IV-Einsatz	IL148118-	295,20	IV-Einsatz	IL148218-	304,30	IV-Einsatz	IL148318-	340,40	
	Mauerwanne	IL369118-F	236,50	Mauerwanne	IL369218-F	248,80	Mauerwanne	IL369318-F	289,30	
	Rückwand	IL042118-F	40,24	Rückwand	IL042218-F	48,20	Rückwand	IL042318-F	65,02	
7 IR	1A-21 K	IL172121AS	875,70	2A-21 K	IL172221AS	957,40	3A-21 K	IL172321AS	1.071,00	T = 250 T = 250 T = 200
	1U-21 K	IL172121US	881,00	2U-21 K	IL172221US	967,50	3U-21 K	IL172321US	1.072,00	
21	1M-21 K	IL172121MS	558,90	2M-21 K	IL172221MS	578,10	3M-21 K	IL172321MS	647,00	A = 1055 A = 1055 M = 1010 E = 970 P = 1025
	AP-Rahmen	IL006121-F	490,30	AP-Rahmen	IL006221-F	556,00	AP-Rahmen	IL006321-F	608,70	
	UP-Rahmen	IL308121-F	294,70	UP-Rahmen	IL308221-F	330,90	UP-Rahmen	IL308321-F	362,00	
	MV-Rahmen	IL078121-	173,50	MV-Rahmen	IL078221-	176,70	MV-Rahmen	IL078321-	184,80	
	IV-Einsatz	IL148121-	337,80	IV-Einsatz	IL148221-	348,40	IV-Einsatz	IL148321-	390,50	
	Mauerwanne	IL369121-F	248,50	Mauerwanne	IL369221-F	288,20	Mauerwanne	IL369321-F	319,70	
	Rückwand	IL042121-F	47,57	Rückwand	IL042221-F	52,95	Rückwand	IL042321-F	71,68	
8 IR	1A-24 K	IL172124AS	964,60	2A-24 K	IL172224AS	1.077,00	3A-24 K	IL172324AS	1.219,00	T = 250 T = 250 T = 200
	1U-24 K	IL172124US	1.037,00	2U-24 K	IL172224US	1.070,00	3U-24 K	IL172324US	1.175,00	
24	1M-24 K	IL172124MS	613,70	2M-24 K	IL172224MS	636,30	3M-24 K	IL172324MS	713,70	A = 1195 A = 1195 M = 1150 E = 1105 P = 1165
	AP-Rahmen	IL006124-F	533,10	AP-Rahmen	IL006224-F	626,60	AP-Rahmen	IL006324-F	699,20	
	UP-Rahmen	IL308124-F	372,00	UP-Rahmen	IL308224-F	381,90	UP-Rahmen	IL308324-F	405,00	
	MV-Rahmen	IL078124-	182,20	MV-Rahmen	IL078224-	185,40	MV-Rahmen	IL078324-	193,50	
	IV-Einsatz	IL148124-	379,10	IV-Einsatz	IL148224-	391,30	IV-Einsatz	IL148324-	439,40	
	Mauerwanne	IL369124-F	285,60	Mauerwanne	IL369224-F	296,60	Mauerwanne	IL369324-F	330,50	
	Rückwand	IL042124-F	52,43	Rückwand	IL042224-F	59,58	Rückwand	IL042324-F	80,77	
9 IR	1A-28 K	IL172128AS	1.094,00	2A-28 K	IL172228AS	1.232,00	3A-28 K	IL172328AS	1.349,00	T = 250 T = 250 T = 200
	1U-28 K	IL172128US	1.117,00	2U-28 K	IL172228US	1.192,00	3U-28 K	IL172328US	1.290,00	
28	1M-28 K	IL172128MS	677,10	2M-28 K	IL172228MS	708,20	3M-28 K	IL172328MS	797,70	A = 1380 A = 1380 M = 1335 E = 1290 P = 1350
	AP-Rahmen	IL006128-F	617,00	AP-Rahmen	IL006228-F	727,10	AP-Rahmen	IL006328-F	763,10	
	UP-Rahmen	IL308128-F	401,60	UP-Rahmen	IL308228-F	426,30	UP-Rahmen	IL308328-F	441,00	
	MV-Rahmen	IL078128-	200,50	MV-Rahmen	IL078228-	203,70	MV-Rahmen	IL078328-	211,80	
	IV-Einsatz	IL148128-	417,50	IV-Einsatz	IL148228-	434,80	IV-Einsatz	IL148328-	491,80	
	Mauerwanne	IL369128-F	298,00	Mauerwanne	IL369228-F	331,10	Mauerwanne	IL369328-F	357,10	
	Rückwand	IL042128-F	59,11	Rückwand	IL042228-F	69,66	Rückwand	IL042328-F	94,06	
11 IR				2A-33 K	IL172233AS	1.412,00	3A-33 K	IL172333AS	1.571,00	T = 250 T = 250 T = 200
				2U-33 K	IL172233US	1.372,00	3U-33 K	IL172333US	1.508,00	
33				2M-33 K	IL172233MS	837,20	3M-33 K	IL172333MS	947,90	A = 1605 A = 1605 M = 1565 E = 1520 P = 1575
				AP-Rahmen	IL006233-F	791,00	AP-Rahmen	IL006333-F	847,10	
				UP-Rahmen	IL308233-F	487,10	UP-Rahmen	IL308333-F	500,00	
				MV-Rahmen	IL078233-	215,90	MV-Rahmen	IL078333-	224,00	
				IV-Einsatz	IL148233-	531,90	IV-Einsatz	IL148333-	598,10	
				Mauerwanne	IL369233-F	353,20	Mauerwanne	IL369333-F	410,20	
				Rückwand	IL042233-F	89,36	Rückwand	IL042333-F	125,80	
13 IR				2A-39 K	IL172239AS	1.645,00	3A-39 K	IL172339AS	1.816,00	T = 250 T = 250 T = 200
				2U-39 K	IL172239US	1.598,00	3U-39 K	IL172339US	1.759,00	
39				2M-39 K	IL172239MS	979,40	3M-39 K	IL172339MS	1.101,00	A = 1885 A = 1885 M = 1855 E = 1795 P = 1885
				AP-Rahmen	IL006239-F	896,50	AP-Rahmen	IL006339-F	954,00	
				UP-Rahmen	IL308239-F	561,70	UP-Rahmen	IL308339-F	592,40	
				MV-Rahmen	IL078239-	231,00	MV-Rahmen	IL078339-	239,10	
				IV-Einsatz	IL148239-	638,80	IV-Einsatz	IL148339-	717,10	
				Mauerwanne	IL369239-F	397,30	Mauerwanne	IL369339-F	449,30	
				Rückwand	IL042239-F	109,60	Rückwand	IL042339-F	144,90	
14 IR				2A-42 K	IL172242AS	1.790,00	3A-42 K	IL172342AS	1.966,00	T = 250 T = 250 T = 200
				2U-42 K	IL172242US	1.719,00	3U-42 K	IL172342US	1.878,00	
42				2M-42 K	IL172242MS	1.069,00	3M-42 K	IL172342MS	1.192,00	A = 2025 A = 2025 M = 1995 E = 1935 P = 1995
				AP-Rahmen	IL006242-F	998,30	AP-Rahmen	IL006342-F	1.059,00	
				UP-Rahmen	IL308242-F	635,70	UP-Rahmen	IL308342-F	653,80	
				MV-Rahmen	IL078242-	277,00	MV-Rahmen	IL078342-	285,10	
				IV-Einsatz	IL148242-	671,70	IV-Einsatz	IL148342-	756,00	
				Mauerwanne	IL369242-F	411,60	Mauerwanne	IL369342-F	468,00	
				Rückwand	IL042242-F	119,90	Rückwand	IL042342-F	150,70	
15 IR				2A-45 K	IL172245AS	1.923,00	3A-45 K	IL172345AS	2.229,00	T = 250 T = 250 T = 200
				2U-45 K	IL172245US	1.936,00	3U-45 K	IL172345US	2.121,00	
45				2M-45 K	IL172245MS	1.180,00	3M-45 K	IL172345MS	1.326,00	A = 2160 A = 2160 M = 2130 E = 2070 P = 2130
				AP-Rahmen	IL006245-F	1.065,00	AP-Rahmen	IL006345-F	1.233,00	
				UP-Rahmen	IL308245-F	703,20	UP-Rahmen	IL308345-F	741,80	
				MV-Rahmen	IL078245-	321,90	MV-Rahmen	IL078345-	330,00	
				IV-Einsatz	IL148245-	741,30	IV-Einsatz	IL148345-	831,60	
				Mauerwanne	IL369245-F	491,00	Mauerwanne	IL369345-F	547,40	
				Rückwand	IL042245-F	116,60	Rückwand	IL042345-F	164,10	

Breite
(mm)*

Außenmaß UP/AP = 380
Masken-Außenmaß = 330
IV-Einsatz = 290
Putznische = 370

Außenmaß UP/AP = 590
Masken-Außenmaß = 540
IV-Einsatz = 500
Putznische = 580

Außenmaß UP/AP = 810
Masken-Außenmaß = 760
IV-Einsatz = 720
Putznische = 800

*) Toleranzen: + 0 E - 3 mm, Mauerwammentiefe 250 mm

T = Tiefe, A = Außenmaß UP/AP, M = Masken-Außenmaß, E = IV-Einsatz, P = Putznische

Installationsverteiler - Frontblende Stahlblech

Modul-Einheiten		4 ZÄHLERBREITE 45 TE pro Frontplatte			5 ZÄHLERBREITE 57 TE pro Frontplatte			Höhe (mm)*
4 IR 12		4A-12 K	IL177412AS	883,80				T = 180
		4U-12 K	IL172412US	860,50				T = 250
		4M-12 K	IL172412MS	473,60				T = 200
		AP-Rahmen	IL006412-F	587,30				A = 640
		UP-Rahmen	IL308412-F	362,90				A = 640
		MV-Rahmen	IL078412-	177,10				M = 595
		IV-Einsatz	IL148412-	241,80				E = 555
		Mauerwanne	IL369412-F	255,80				P = 630
		Rückwand	IL042412-F	54,67				
6 IR 18		4A-18 K	IL172418AS	1.077,00				T = 250
		4U-18 K	IL172418US	1.107,00				T = 250
		4M-18 K	IL172418MS	636,20				T = 200
		AP-Rahmen	IL006418-F	625,20				A = 915
		UP-Rahmen	IL308418-F	405,00				A = 915
		MV-Rahmen	IL078418-	184,20				M = 875
		IV-Einsatz	IL148418-	372,80				E = 830
		Mauerwanne	IL369418-F	329,30				P = 885
		Rückwand	IL042418-F	79,18				
7 IR 21		4A-21 K	IL172421AS	1.263,00				T = 250
		4U-21 K	IL172421US	1.240,00				T = 250
		4M-21 K	IL172421MS	711,70				T = 200
		AP-Rahmen	IL006421-F	746,80				A = 1055
		UP-Rahmen	IL308421-F	478,70				A = 1055
		MV-Rahmen	IL078421-	195,60				M = 1010
		IV-Einsatz	IL148421-	428,30				E = 970
		Mauerwanne	IL369421-F	333,40				P = 1025
		Rückwand	IL042421-F	87,79				
8 IR 24		4A-24 K	IL172424AS	1.437,00	5A-24 K	IL172524AS	1.795,00	T = 250
		4U-24 K	IL172424US	1.372,00	5U-24 K	IL172524US	1.658,00	T = 250
		4M-24 K	IL172424MS	789,00	5M-24 K	IL172524MS	1.015,00	T = 200
		AP-Rahmen	IL006424-F	852,00	AP-Rahmen	IL006524-F	1.083,00	A = 1195
		UP-Rahmen	IL308424-F	543,00	UP-Rahmen	IL308524-F	695,90	A = 1195
		MV-Rahmen	IL078424-	204,30	MV-Rahmen	IL078524-	303,60	M = 1150
		IV-Einsatz	IL148424-	482,60	IV-Einsatz	IL148524-	562,60	E = 1105
		Mauerwanne	IL369424-F	346,50	Mauerwanne	IL369524-F	399,80	P = 1165
		Rückwand	IL042424-F	102,10	Rückwand	IL042524-F	149,10	
9 IR 28		4A-28 K	IL172428AS	1.637,00	5A-28 K	IL172528AS	1.975,00	T = 250
		4U-28 K	IL172428US	1.520,00	5U-28 K	IL172528US	1.893,00	T = 250
		4M-28 K	IL172428MS	887,20	5M-28 K	IL172528MS	1.140,00	T = 200
		AP-Rahmen	IL006428-F	971,90	AP-Rahmen	IL006528-F	1.157,00	A = 1380
		UP-Rahmen	IL308428-F	593,50	UP-Rahmen	IL308528-F	741,80	A = 1380
		MV-Rahmen	IL078428-	222,60	MV-Rahmen	IL078528-	321,90	M = 1335
		IV-Einsatz	IL148428-	545,60	IV-Einsatz	IL148528-	635,20	E = 1290
		Mauerwanne	IL369428-F	381,20	Mauerwanne	IL369528-F	516,10	P = 1350
		Rückwand	IL042428-F	119,00	Rückwand	IL042528-F	183,20	
11 IR 33		4A-33 K	IL172433AS	1.866,00	5A-33 K	IL172533AS	2.219,00	T = 250
		4U-33 K	IL172433US	1.732,00	5U-33 K	IL172533US	2.121,00	T = 210
		4M-33 K	IL172433MS	1.045,00	5M-33 K	IL172533MS	1.310,00	T = 200
		AP-Rahmen	IL006433-F	1.055,00	AP-Rahmen	IL006533-F	1.243,00	A = 1605
		UP-Rahmen	IL308433-F	639,00	UP-Rahmen	IL308533-F	818,30	A = 1605
		MV-Rahmen	IL078433-	234,80	MV-Rahmen	IL078533-	334,10	M = 1565
		IV-Einsatz	IL148433-	657,50	IV-Einsatz	IL148533-	767,40	E = 1520
		Mauerwanne	IL369433-F	435,00	Mauerwanne	IL369533-F	535,10	P = 1575
		Rückwand	IL042433-F	153,00	Rückwand	IL042533-F	208,20	
13 IR 39		4A-39 K	IL172439AS	2.141,00	5A-39 K	IL172539AS	2.522,00	T = 250
		4U-39 K	IL172439US	2.044,00	5U-39 K	IL172539US	2.414,00	T = 250
		4M-39 K	IL172439MS	1.215,00	5M-39 K	IL172539MS	1.505,00	T = 200
		AP-Rahmen	IL006439-F	1.176,00	AP-Rahmen	IL006539-F	1.366,00	A = 1885
		UP-Rahmen	IL308439-F	773,90	UP-Rahmen	IL308539-F	902,20	A = 1885
		MV-Rahmen	IL078439-	249,90	MV-Rahmen	IL078539-	349,20	M = 1855
		IV-Einsatz	IL148439-	787,30	IV-Einsatz	IL148539-	917,10	E = 1795
		Mauerwanne	IL369439-F	482,90	Mauerwanne	IL369539-F	594,60	P = 1885
		Rückwand	IL042439-F	177,40	Rückwand	IL042539-F	238,40	
14 IR 42		4A-42 K	IL172442AS	2.251,00	5A-42 K	IL172542AS	2.711,00	T = 250
		4U-42 K	IL172442US	2.222,00	5U-42 K	IL172542US	2.633,00	T = 250
		4M-42 K	IL172442MS	1.311,00	5M-42 K	IL172542MS	1.619,00	T = 200
		AP-Rahmen	IL006442-F	1.236,00	AP-Rahmen	IL006542-F	1.487,00	A = 2025
		UP-Rahmen	IL308442-F	861,00	UP-Rahmen	IL308542-F	988,30	A = 2025
		MV-Rahmen	IL078442-	295,90	MV-Rahmen	IL078542-	395,20	M = 1995
		IV-Einsatz	IL148442-	831,60	IV-Einsatz	IL148542-	971,50	E = 1935
		Mauerwanne	IL369442-F	529,60	Mauerwanne	IL369542-F	672,90	P = 1995
		Rückwand	IL042442-F	183,40	Rückwand	IL042542-F	252,50	
15 IR 45		4A-45 K	IL172445AS	2.409,00	5A-45 K	IL172545AS	2.960,00	T = 250
		4U-45 K	IL172445US	2.502,00	5U-45 K	IL172545US	2.971,00	T = 250
		4M-45 K	IL172445MS	1.455,00	5M-45 K	IL172545MS	1.770,00	T = 200
		AP-Rahmen	IL006445-F	1.294,00	AP-Rahmen	IL006545-F	1.630,00	A = 2160
		UP-Rahmen	IL308445-F	955,60	UP-Rahmen	IL308545-F	1.117,00	A = 2160
		MV-Rahmen	IL078445-	340,80	MV-Rahmen	IL078545-	440,10	M = 2130
		IV-Einsatz	IL148445-	912,60	IV-Einsatz	IL148545-	1.062,00	E = 2070
		Mauerwanne	IL369445-F	633,50	Mauerwanne	IL369545-F	792,00	P = 2130
		Rückwand	IL042445-F	202,00	Rückwand	IL042545-F	267,70	
Breite (mm)*		Außenmaß UP/AP = 1030 Masken-Außenmaß = 980 IV-Einsatz = 940 Putznische = 1020			Außenmaß UP/AP = 1230 Masken-Außenmaß = 1180 IV-Einsatz = 1140 Putznische = 1220			

T = Tiefe, A = Außenmaß UP/AP, M = Masken-Außenmaß, E = IV-Einsatz, P = Putznische

*) Toleranzen: + 0 E. - 3 mm, Mauerwammentiefe 250 mm

Installationsverteiler - Frontblende Kunststoff

Modul- Einheiten	1 ZÄHLERBREITE 13 TE pro Frontplatte			2 ZÄHLERBREITE 21 TE pro Frontplatte			3 ZÄHLERBREITE 33 TE pro Frontplatte			Höhe (mm)*
4 IR 12	1A-12 L	IL172112AK	519,10	2A-12 L	IL172212AK	606,20	3A-12 L	IL172312AK	700,10	T = 180 T = 250 T = 200 A = 640 A = 640 M = 595 E = 555 P = 630
	1U-12 L	IL172112UK	612,90	2U-12 L	IL172212UK	655,60	3U-12 L	IL172312UK	776,30	
	1M-12 L	IL172112MK	371,10	2M-12 L	IL172212MK	406,50	3M-12 L	IL172312MK	435,00	
	AP-Rahmen	IL006112-F	302,90	AP-Rahmen	IL006212-F	357,80	AP-Rahmen	IL006312-F	431,30	
	UP-Rahmen	IL308112-F	212,60	UP-Rahmen	IL308212-F	228,20	UP-Rahmen	IL308312-F	280,80	
	MV-Rahmen	IL078112-	154,90	MV-Rahmen	IL078212-	158,10	MV-Rahmen	IL078312-	166,20	
	IV-Einsatz	IL149112-	186,10	IV-Einsatz	IL149212-	214,20	IV-Einsatz	IL149312-	224,90	
	Mauerwanne	IL369112-F	214,20	Mauerwanne	IL369212-F	213,20	Mauerwanne	IL369312-F	270,60	
	Rückwand	IL042112-F	30,12	Rückwand	IL042212-F	34,15	Rückwand	IL042312-F	43,94	
6 IR 18	1A-18 L	IL172118AK	699,90	2A-18 L	IL172218AK	836,90	3A-18 L	IL172318AK	930,80	T = 250 T = 250 T = 200 A = 915 A = 915 M = 875 E = 830 P = 885
	1U-18 L	IL172118UK	758,00	2U-18 L	IL172218UK	856,00	3U-18 L	IL172318UK	959,60	
	1M-18 L	IL172118MK	491,50	2M-18 L	IL172218MK	544,80	3M-18 L	IL172318MK	585,80	
	AP-Rahmen	IL006118-F	370,40	AP-Rahmen	IL006218-F	457,30	AP-Rahmen	IL006318-F	518,30	
	UP-Rahmen	IL308118-F	232,20	UP-Rahmen	IL308218-F	275,80	UP-Rahmen	IL308318-F	322,80	
	MV-Rahmen	IL078118-	162,00	MV-Rahmen	IL078218-	165,20	MV-Rahmen	IL078318-	173,30	
	IV-Einsatz	IL149118-	289,30	IV-Einsatz	IL149218-	331,40	IV-Einsatz	IL149318-	347,50	
	Mauerwanne	IL369118-F	236,50	Mauerwanne	IL369218-F	248,80	Mauerwanne	IL369318-F	289,30	
	Rückwand	IL042118-F	40,24	Rückwand	IL042218-F	48,20	Rückwand	IL042318-F	65,02	
7 IR 21	1A-21 L	IL172121AK	868,70	2A-21 L	IL172221AK	989,00	3A-21 L	IL172321AK	1.079,00	T = 250 T = 250 T = 200 A = 1055 A = 1055 M = 1010 E = 970 P = 1025
	1U-21 L	IL172121UK	874,00	2U-21 L	IL172221UK	999,10	3U-21 L	IL172321UK	1.080,00	
	1M-21 L	IL172121MK	551,90	2M-21 L	IL172221MK	609,70	3M-21 L	IL172321MK	655,20	
	AP-Rahmen	IL006121-F	490,30	AP-Rahmen	IL006221-F	556,00	AP-Rahmen	IL006321-F	608,70	
	UP-Rahmen	IL308121-F	294,70	UP-Rahmen	IL308221-F	330,90	UP-Rahmen	IL308321-F	362,00	
	MV-Rahmen	IL078121-	173,50	MV-Rahmen	IL078221-	176,70	MV-Rahmen	IL078321-	184,80	
	IV-Einsatz	IL149121-	330,80	IV-Einsatz	IL149221-	380,00	IV-Einsatz	IL149321-	398,70	
	Mauerwanne	IL369121-F	248,50	Mauerwanne	IL369221-F	288,20	Mauerwanne	IL369321-F	319,70	
	Rückwand	IL042121-F	47,57	Rückwand	IL042221-F	52,95	Rückwand	IL042321-F	71,68	
8 IR 24	1A-24 L	IL172124AK	956,70	2A-24 L	IL172224AK	1.114,00	3A-24 L	IL172324AK	1.229,00	T = 250 T = 250 T = 200 A = 1195 A = 1195 M = 1150 E = 1105 P = 1165
	1U-24 L	IL172124UK	1.029,00	2U-24 L	IL172224UK	1.106,00	3U-24 L	IL172324UK	1.184,00	
	1M-24 L	IL172124MK	605,80	2M-24 L	IL172224MK	672,40	3M-24 L	IL172324MK	723,10	
	AP-Rahmen	IL006124-F	533,10	AP-Rahmen	IL006224-F	626,60	AP-Rahmen	IL006324-F	699,20	
	UP-Rahmen	IL308124-F	372,00	UP-Rahmen	IL308224-F	381,90	UP-Rahmen	IL308324-F	405,00	
	MV-Rahmen	IL078124-	182,20	MV-Rahmen	IL078224-	185,40	MV-Rahmen	IL078324-	193,50	
	IV-Einsatz	IL149124-	371,20	IV-Einsatz	IL149224-	427,40	IV-Einsatz	IL149324-	448,80	
	Mauerwanne	IL369124-F	285,60	Mauerwanne	IL369224-F	296,60	Mauerwanne	IL369324-F	330,50	
	Rückwand	IL042124-F	52,43	Rückwand	IL042224-F	59,58	Rückwand	IL042324-F	80,77	
9 IR 28	1A-28 L	IL172128AK	1.091,00	2A-28 L	IL172228AK	1.275,00	3A-28 L	IL172328AK	1.364,00	T = 250 T = 250 T = 200 A = 1380 A = 1380 M = 1335 E = 1290 P = 1350
	1U-28 L	IL172128UK	1.114,00	2U-28 L	IL172228UK	1.235,00	3U-28 L	IL172328UK	1.305,00	
	1M-28 L	IL172128MK	674,20	2M-28 L	IL172228MK	751,40	3M-28 L	IL172328MK	813,20	
	AP-Rahmen	IL006128-F	617,00	AP-Rahmen	IL006228-F	727,10	AP-Rahmen	IL006328-F	763,10	
	UP-Rahmen	IL308128-F	401,60	UP-Rahmen	IL308228-F	426,30	UP-Rahmen	IL308328-F	441,00	
	MV-Rahmen	IL078128-	200,50	MV-Rahmen	IL078228-	203,70	MV-Rahmen	IL078328-	211,80	
	IV-Einsatz	IL149128-	414,60	IV-Einsatz	IL149228-	478,00	IV-Einsatz	IL149328-	507,30	
	Mauerwanne	IL369128-F	298,00	Mauerwanne	IL369228-F	331,10	Mauerwanne	IL369328-F	357,10	
	Rückwand	IL042128-F	59,11	Rückwand	IL042228-F	69,66	Rückwand	IL042328-F	94,06	
11 IR 33				2A-33 L	IL172233AK	1.462,00	3A-33 L	IL172333AK	1.584,00	T = 250 T = 250 T = 200 A = 1605 A = 1605 M = 1565 E = 1520 P = 1575
				2U-33 L	IL172233UK	1.422,00	3U-33 L	IL172333UK	1.521,00	
				2M-33 L	IL172233MK	886,80	3M-33 L	IL172333MK	960,80	
				AP-Rahmen	IL006233-F	791,00	AP-Rahmen	IL006333-F	847,10	
				UP-Rahmen	IL308233-F	487,10	UP-Rahmen	IL308333-F	500,00	
				MV-Rahmen	IL078233-	215,90	MV-Rahmen	IL078333-	224,00	
				IV-Einsatz	IL149233-	581,50	IV-Einsatz	IL149333-	611,00	
				Mauerwanne	IL369233-F	353,20	Mauerwanne	IL369333-F	410,20	
				Rückwand	IL042233-F	89,36	Rückwand	IL042333-F	125,80	
13 IR 39				2A-39 L	IL172239AK	1.704,00	3A-39 L	IL172339AK	1.831,00	T = 250 T = 250 T = 200 A = 1885 A = 1885 M = 1855 E = 1795 P = 1885
				2U-39 L	IL172239UK	1.656,00	3U-39 L	IL172339UK	1.774,00	
				2M-39 L	IL172239MK	1.038,00	3M-39 L	IL172339MK	1.116,00	
				AP-Rahmen	IL006239-F	896,50	AP-Rahmen	IL006339-F	954,00	
				UP-Rahmen	IL308239-F	561,70	UP-Rahmen	IL308339-F	592,40	
				MV-Rahmen	IL078239-	231,00	MV-Rahmen	IL078339-	239,10	
				IV-Einsatz	IL149239-	697,40	IV-Einsatz	IL149339-	732,30	
				Mauerwanne	IL369239-F	397,30	Mauerwanne	IL369339-F	449,30	
				Rückwand	IL042239-F	109,60	Rückwand	IL042339-F	144,90	
14 IR 42				2A-42 L	IL172242AK	1.853,00	3A-42 L	IL172342AK	1.982,00	T = 250 T = 250 T = 200 A = 2025 A = 2025 M = 1995 E = 1935 P = 1995
				2U-42 L	IL172242UK	1.782,00	3U-42 L	IL172342UK	1.894,00	
				2M-42 L	IL172242MK	1.132,00	3M-42 L	IL172342MK	1.208,00	
				AP-Rahmen	IL006242-F	998,30	AP-Rahmen	IL006342-F	1.059,00	
				UP-Rahmen	IL308242-F	635,70	UP-Rahmen	IL308342-F	653,80	
				MV-Rahmen	IL078242-	277,00	MV-Rahmen	IL078342-	285,10	
				IV-Einsatz	IL149242-	734,90	IV-Einsatz	IL149342-	772,40	
				Mauerwanne	IL369242-F	411,60	Mauerwanne	IL369342-F	468,00	
				Rückwand	IL042242-F	119,90	Rückwand	IL042342-F	150,70	
15 IR 45				2A-45 L	IL172245AK	1.991,00	3A-45 L	IL172345AK	2.246,00	T = 250 T = 250 T = 200 A = 2160 A = 2160 M = 2130 E = 2070 P = 2130
				2U-45 L	IL172245UK	2.003,00	3U-45 L	IL172345UK	2.138,00	
				2M-45 L	IL172245MK	1.248,00	3M-45 L	IL172345MK	1.343,00	
				AP-Rahmen	IL006245-F	1.065,00	AP-Rahmen	IL006345-F	1.233,00	
				UP-Rahmen	IL308245-F	703,20	UP-Rahmen	IL308345-F	741,80	
				MV-Rahmen	IL078245-	321,90	MV-Rahmen	IL078345-	330,00	
				IV-Einsatz	IL149245-	809,00	IV-Einsatz	IL149345-	849,20	
				Mauerwanne	IL369245-F	491,00	Mauerwanne	IL369345-F	547,40	
				Rückwand	IL042245-F	116,60	Rückwand	IL042345-F	164,10	

Installationsverteiler - Frontblende Kunststoff







Modul- Einheiten		4 ZÄHLERBREITE 45 TE pro Frontplatte	5 ZÄHLERBREITE 57 TE pro Frontplatte	Höhe (mm)*
4 IR		4A-12 L IL172412AK 930,40		T = 180 T = 250 T = 200
		4U-12 L IL172412UK 907,10		
12		4M-12 L IL172412MK 520,20		A = 640 A = 640 M = 595 E = 555 P = 630
		AP-Rahmen IL006412-F 587,30		
		UP-Rahmen IL308412-F 362,90		
		MV-Rahmen IL078412- 177,10		
		IV-Einsatz IL149412- 288,40		
		Mauerwanne IL369412-F 255,80		
		Rückwand IL042412-F 54,67		
6 IR		4A-18 L IL172418AK 1.147,00		T = 250 T = 250 T = 200
		4U-18 L IL172418UK 1.177,00		
18		4M-18 L IL172418MK 706,10		A = 915 A = 915 M = 875 E = 830 P = 885
		AP-Rahmen IL006418-F 625,20		
		UP-Rahmen IL308418-F 405,00		
		MV-Rahmen IL078418- 184,20		
		IV-Einsatz IL149418- 442,70		
		Mauerwanne IL369418-F 329,30		
		Rückwand IL042418-F 79,18		
7 IR		4A-21 L IL172421AK 1.344,00		T = 250 T = 250 T = 200
		4U-21 L IL172421UK 1.322,00		
21		4M-21 L IL172421MK 793,20		A = 1055 A = 1055 M = 1010 E = 970 P = 1025
		AP-Rahmen IL006421-F 746,80		
		UP-Rahmen IL308421-F 478,70		
		MV-Rahmen IL078421- 195,60		
		IV-Einsatz IL149421- 509,80		
		Mauerwanne IL369421-F 333,40		
		Rückwand IL042421-F 87,79		
8 IR		4A-24 L IL172424AK 1.530,00	5A-24 L IL172524AK 1.833,00	T = 250 T = 250 T = 200
		4U-24 L IL172424UK 1.465,00	5U-24 L IL172524UK 1.696,00	
24		4M-24 L IL172424MK 882,20	5M-24 L IL172524MK 1.053,00	A = 1195 A = 1195 M = 1150 E = 1105 P = 1165
		AP-Rahmen IL006424-F 852,00	AP-Rahmen IL006524-F 1.083,00	
		UP-Rahmen IL308424-F 543,00	UP-Rahmen IL308524-F 695,90	
		MV-Rahmen IL078424- 204,30	MV-Rahmen IL078524- 303,60	
		IV-Einsatz IL149424- 575,80	IV-Einsatz IL149524- 600,60	
		Mauerwanne IL369424-F 346,50	Mauerwanne IL369524-F 399,80	
		Rückwand IL042424-F 102,10	Rückwand IL042524-F 149,10	
9 IR		4A-28 L IL172428AK 1.737,00	5A-28 L IL172528AK 2.015,00	T = 250 T = 250 T = 200
		4U-28 L IL172428UK 1.620,00	5U-28 L IL172528UK 1.933,00	
28		4M-28 L IL172428MK 987,20	5M-28 L IL172528MK 1.180,00	A = 1380 A = 1380 M = 1335 E = 1290 P = 1350
		AP-Rahmen IL006428-F 971,90	AP-Rahmen IL006528-F 1.157,00	
		UP-Rahmen IL308428-F 593,50	UP-Rahmen IL308528-F 741,80	
		MV-Rahmen IL078428- 222,60	MV-Rahmen IL078528- 321,90	
		IV-Einsatz IL149428- 645,60	IV-Einsatz IL149528- 674,90	
		Mauerwanne IL369428-F 381,20	Mauerwanne IL369528-F 516,10	
		Rückwand IL042428-F 119,00	Rückwand IL042528-F 183,20	
11 IR		4A-33 L IL172433AK 1.994,00	5A-33 L IL172533AK 2.271,00	T = 250 T = 210 T = 200
		4U-33 L IL172433UK 1.860,00	5U-33 L IL172533UK 2.173,00	
33		4M-33 L IL172433MK 1.173,00	5M-33 L IL172533MK 1.362,00	A = 1605 A = 1605 M = 1565 E = 1520 P = 1575
		AP-Rahmen IL006433-F 1.055,00	AP-Rahmen IL006533-F 1.243,00	
		UP-Rahmen IL308433-F 639,00	UP-Rahmen IL308533-F 818,30	
		MV-Rahmen IL078433- 234,80	MV-Rahmen IL078533- 334,10	
		IV-Einsatz IL149433- 785,50	IV-Einsatz IL149533- 819,60	
		Mauerwanne IL369433-F 435,00	Mauerwanne IL369533-F 535,10	
		Rückwand IL042433-F 153,00	Rückwand IL042533-F 208,20	
13 IR		4A-39 L IL172439AK 2.292,00	5A-39 L IL172539AK 2.583,00	T = 250 T = 250 T = 200
		4U-39 L IL172439UK 2.195,00	5U-39 L IL172539UK 2.476,00	
39		4M-39 L IL172439MK 1.366,00	5M-39 L IL172539MK 1.567,00	A = 1885 A = 1885 M = 1855 E = 1795 P = 1885
		AP-Rahmen IL006439-F 1.176,00	AP-Rahmen IL006539-F 1.366,00	
		UP-Rahmen IL308439-F 773,90	UP-Rahmen IL308539-F 902,20	
		MV-Rahmen IL078439- 249,90	MV-Rahmen IL078539- 349,20	
		IV-Einsatz IL149439- 938,60	IV-Einsatz IL149539- 978,90	
		Mauerwanne IL369439-F 482,90	Mauerwanne IL369539-F 594,60	
		Rückwand IL042439-F 177,40	Rückwand IL042539-F 238,40	
14 IR		4A-42 L IL172442AK 2.414,00	5A-42 L IL172542AK 2.778,00	T = 250 T = 250 T = 200
		4U-42 L IL172442UK 2.385,00	5U-42 L IL172542UK 2.699,00	
42		4M-42 L IL172442MK 1.474,00	5M-42 L IL172542MK 1.686,00	A = 2025 A = 2025 M = 1995 E = 1935 P = 1995
		AP-Rahmen IL006442-F 1.236,00	AP-Rahmen IL006542-F 1.487,00	
		UP-Rahmen IL308442-F 861,00	UP-Rahmen IL308542-F 988,30	
		MV-Rahmen IL078442- 295,90	MV-Rahmen IL078542- 395,20	
		IV-Einsatz IL149442- 994,60	IV-Einsatz IL149542- 1.038,00	
		Mauerwanne IL369442-F 529,60	Mauerwanne IL369542-F 672,90	
		Rückwand IL042442-F 183,40	Rückwand IL042542-F 252,50	
15 IR		4A-45 L IL172445AK 2.583,00	5A-45 L IL172545AK 3.032,00	T = 250 T = 250 T = 200
		4U-45 L IL172445UK 2.676,00	5U-45 L IL172545UK 3.043,00	
45		4M-45 L IL172445MK 1.630,00	5M-45 L IL172545MK 1.842,00	A = 2160 A = 2160 M = 2130 E = 2070 P = 2130
		AP-Rahmen IL006445-F 1.294,00	AP-Rahmen IL006545-F 1.630,00	
		UP-Rahmen IL308445-F 955,60	UP-Rahmen IL308545-F 1.117,00	
		MV-Rahmen IL078445- 340,80	MV-Rahmen IL078545- 440,10	
		IV-Einsatz IL149445- 1.087,00	IV-Einsatz IL149545- 1.134,00	
		Mauerwanne IL369445-F 633,50	Mauerwanne IL369545-F 792,00	
		Rückwand IL042445-F 202,00	Rückwand IL042545-F 267,70	
Breite (mm)*		Außenmaß UP/AP = 1030 Masken-Außenmaß = 980 IV-Einsatz = 940 Putznische = 1020	Außenmaß UP/AP = 1230 Masken-Außenmaß = 1180 IV-Einsatz = 1140 Putznische = 1220	

T = Tiefe, A = Außenmaß UP/AP, M = Masken-Außenmaß, E = IV-Einsatz, P = Putznische



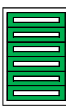

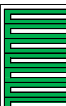





*) Toleranzen: + 0 E - 3 mm, Mauerwammentiefe 250 mm

Verteilersystem Modul 2000 – Installationsverteiler

Installationsverteiler Tiefe 100mm – Frontblende Stahlblech

Modul-Einheiten	1 ZÄHLERBREITE 13 TE pro Frontplatte	2 ZÄHLERBREITE 21 TE pro Frontplatte	3 ZÄHLERBREITE 33 TE pro Frontplatte	Höhe (mm)*
4 IR 12		2A-12 K IL172912AS 519,70 2U-12 K IL172912US 509,40  AP-Rahmen IL006912-F 310,60 UP-Rahmen IL012212-F 216,60 IV-Einsatz IL148912- 174,90 Mauerwanne IL067212-F 117,90 Rückwand IL042212-F 34,15	3U-12 K IL172812US 596,50  UP-Rahmen IL012312-F 266,90 IV-Einsatz IL148812- 196,90 Mauerwanne IL067312-F 132,70	T = 100 T = 100 A = 640 A = 640 E = 555 P = 630
6 IR 18		2A-18 K IL172918AS 703,20 2U-18 K IL172918US 675,60  AP-Rahmen IL006918-F 383,10 UP-Rahmen IL012218-F 261,80 IV-Einsatz IL148918- 271,90 Mauerwanne IL067218-F 141,90 Rückwand IL042218-F 48,20	3U-18 K IL172818US 783,10  UP-Rahmen IL012318-F 306,20 IV-Einsatz IL148818- 304,90 Mauerwanne IL067318-F 172,00	T = 100 T = 100 A = 915 A = 915 E = 830 P = 885
7 IR 21		2U-21 K IL172921US 812,30  UP-Rahmen IL012221-F 314,10 IV-Einsatz IL148921- 310,50 Mauerwanne IL067221-F 187,70	3U-21 K IL172821US 912,20  UP-Rahmen IL012321-F 344,00 IV-Einsatz IL148821- 349,00 Mauerwanne IL067321-F 219,20	T = 100 A = 1055 E = 970 P = 1025
8 IR 24		2U-24 K IL172924US 920,90  UP-Rahmen IL012224-F 362,90 IV-Einsatz IL148924- 348,70 Mauerwanne IL067224-F 209,30	3U-24 K IL172824US 1.025,00  UP-Rahmen IL012324-F 384,90 IV-Einsatz IL148824- 392,70 Mauerwanne IL067324-F 247,00	T = 100 A = 1195 E = 1105 P = 1165
Breite (mm)*	Außenmaß UP/AP = 380 IV-Einsatz = 290 Putznische = 370	Außenmaß UP/AP = 590 IV-Einsatz = 500 Putznische = 580	Außenmaß UP/AP = 810 IV-Einsatz = 720 Putznische = 800	

Installationsverteiler Tiefe 180mm – Frontblende Stahlblech

Modul-Einheiten	1 ZÄHLERBREITE 13 TE pro Frontplatte	2 ZÄHLERBREITE 21 TE pro Frontplatte	3 ZÄHLERBREITE 33 TE pro Frontplatte	Höhe (mm)*
2 IR 7	1A-7 K IL177107AS 410,70 AP-Rahmen IL006107-F 279,70  IV-Einsatz IL138107- 112,00 Rückwand IL042107-F 19,00	2A-7 K IL177207AS 471,40 2U-7 K IL177207US 418,60  AP-Rahmen IL006207-F 335,80 UP-Rahmen IL308207-F 210,00 IV-Einsatz IL138207- 115,10 Mauerwanne IL068207-F 93,53 Rückwand IL042207-F 20,52		T = 180 T = 180 A = 410 A = 410 E = 325 P = 400
4 IR 12	1A-12 K IL177112AS 539,90 1U-12 K IL177112US 534,30  AP-Rahmen IL006112-F 302,90 UP-Rahmen IL308112-F 212,60 IV-Einsatz IL138112- 206,90 Mauerwanne IL068112-F 114,80 Rückwand IL042112-F 30,12	2A-12 K IL177212AS 588,20 2U-12 K IL177212US 552,00  AP-Rahmen IL006212-F 357,80 UP-Rahmen IL308212-F 228,20 IV-Einsatz IL138212- 196,20 Mauerwanne IL068212-F 127,60 Rückwand IL042212-F 34,15	3A-12 K IL177312AS 695,40  AP-Rahmen IL006312-F 431,30 IV-Einsatz IL138312- 220,20 Rückwand IL042312-F 43,94	T = 180 T = 180 A = 640 A = 640 E = 555 P = 630
6 IR 18	1U-18 K IL177118US 700,00  UP-Rahmen IL308118-F 232,20 IV-Einsatz IL138118- 295,20 Mauerwanne IL068118-F 172,60	2U-18 K IL177218US 719,60  UP-Rahmen IL308218-F 275,80 IV-Einsatz IL138218- 304,30 Mauerwanne IL068218-F 139,50		T = 180 T = 180 A = 915 A = 915 E = 830 P = 885
7 IR 21	1U-21 K IL177121US 829,20  UP-Rahmen IL308121-F 294,70 IV-Einsatz IL138121- 337,80 Mauerwanne IL068121-F 196,70	2U-21 K IL177221US 887,40  UP-Rahmen IL308221-F 330,90 IV-Einsatz IL138221- 348,40 Mauerwanne IL068221-F 208,10		T = 180 A = 1055 E = 970 P = 1025
8 IR 24	1U-24 K IL177124US 973,90  UP-Rahmen IL308124-F 372,00 IV-Einsatz IL138124- 396,00 Mauerwanne IL068124-F 205,90	2U-24 K IL177224US 993,60  UP-Rahmen IL308224-F 381,90 IV-Einsatz IL138224- 391,30 Mauerwanne IL068224-F 220,40		T = 180 A = 1195 E = 1105 P = 1165
Breite (mm)*	Außenmaß UP/AP = 380 IV-Einsatz = 290 Putznische = 370	Außenmaß UP/AP = 590 IV-Einsatz = 500 Putznische = 580	Außenmaß UP/AP = 810 IV-Einsatz = 720 Putznische = 800	

*) Toleranzen: + 0 E. - 3 mm, Mauerwammentiefe 100/180 mm

T = Tiefe, A = Außenmaß UP/AP, E = IV-Einsatz, P = Putznische

■ Installationsverteiler Tiefe 100mm – Frontblende Stahlblech

Modul-Einheiten	4 ZÄHLERBREITE 45 TE pro Frontplatte	5 ZÄHLERBREITE 57 TE pro Frontplatte	Höhe (mm)*
4 IR 12			T = 100 T = 100 A = 640 A = 640 E = 555 P = 630
6 IR 18			T = 100 T = 100 A = 915 A = 915 E = 830 P = 885
7 IR 21			T = 100 A = 1055 E = 970 P = 1025
8 IR 24			T = 100 A = 1195 E = 1105 P = 1165
Breite (mm)*	Außenmaß UP/AP = 1030 IV-Einsatz = 940 Putznische = 1020	Außenmaß UP/AP = 1230 IV-Einsatz = 1140 Putznische = 1220	

■ Installationsverteiler Tiefe 180mm – Frontblende Stahlblech

Modul-Einheiten	4 ZÄHLERBREITE 45 TE pro Frontplatte	5 ZÄHLERBREITE 57 TE pro Frontplatte	Höhe (mm)*												
2 IR 7			T = 180 T = 180 A = 410 A = 410 E = 325 P = 400												
4 IR 12	<div style="display: flex; align-items: center;"> <table style="font-size: small;"> <tr> <td style="padding-right: 10px;">4A-12 K</td> <td style="padding-right: 10px;">IL177412AS</td> <td style="text-align: right;">883,80</td> </tr> <tr> <td>AP-Rahmen</td> <td>IL006412-F</td> <td style="text-align: right;">587,30</td> </tr> <tr> <td>IV-Einsatz</td> <td>IL138412-</td> <td style="text-align: right;">241,80</td> </tr> <tr> <td>Rückwand</td> <td>IL042412-F</td> <td style="text-align: right;">54,67</td> </tr> </table> </div>	4A-12 K	IL177412AS	883,80	AP-Rahmen	IL006412-F	587,30	IV-Einsatz	IL138412-	241,80	Rückwand	IL042412-F	54,67		T = 180 T = 180 A = 640 A = 640 E = 555 P = 630
4A-12 K	IL177412AS	883,80													
AP-Rahmen	IL006412-F	587,30													
IV-Einsatz	IL138412-	241,80													
Rückwand	IL042412-F	54,67													
6 IR 18			T = 180 T = 180 A = 915 A = 915 E = 830 P = 885												
7 IR 21			T = 180 A = 1055 E = 970 P = 1025												
8 IR 24			T = 180 A = 1195 E = 1105 P = 1165												
Breite (mm)*	Außenmaß UP/AP = 1030 IV-Einsatz = 940 Putznische = 1020	Außenmaß UP/AP = 1230 IV-Einsatz = 1140 Putznische = 1220													

*) Toleranzen: + 0 E. - 3 mm, Mauerwammentiefe 100/180 mm

T = Tiefe, A = Außenmaß UP/AP, E = IV-Einsatz, P = Putznische

The image shows a close-up, low-angle view of a large, light-colored industrial electrical cabinet. The top section features several rows of white terminal blocks, each with multiple circular ports. Below this, the cabinet doors are visible, with a bundle of thick, multi-colored cables (brown, blue, and black) secured to the side. The cables have yellow labels with numbers like '22' and '11'. The overall scene is brightly lit, highlighting the organized and professional nature of the equipment.

Ihre Anfrage zu individuellen Verteiler-Ausführungen und -Ausstattungen in Wien, Niederösterreich und Burgenland nimmt Ihr persönlicher Betreuer sehr gerne entgegen.

Alternativ wenden Sie sich bitte an:
SCHRACK TECHNIK GMBH
1230 Wien, Seybelgasse 13
TEL +43(0)1/866 85-5700
E-MAIL wien@schrack.com