

Downlights Serie SEGON ECO LED



LIIM0017-A



LIIM0017-A



LIIM0017-A



LIIM0017-A



LIIM0017-A

Schrack-Info

- Gehäuse: Kunststoff Polyamid (LIIM0021 aus Polycarbonat)
- Abdeckung: Polycarbonat, opal
- Farbtemperatur 3000K/4000K/6500K über einen Schalter einstellbar, 4000K ist voreingestellt
- Dimmbar: Nein
- Lebensdauer: 45.000h (L70/B50)
- Montage: Deckeneinbau
- Schutzart: Frontseite IP44/Rückseite IP20 (Zwischendecke)
- Umgebungstemperatur: -20°C bis +40°C
- Anwendungen: Flure, Stiegehäuser, Nebenräume

30





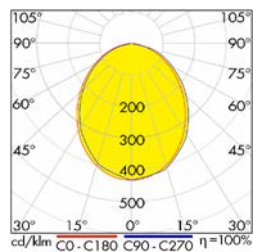
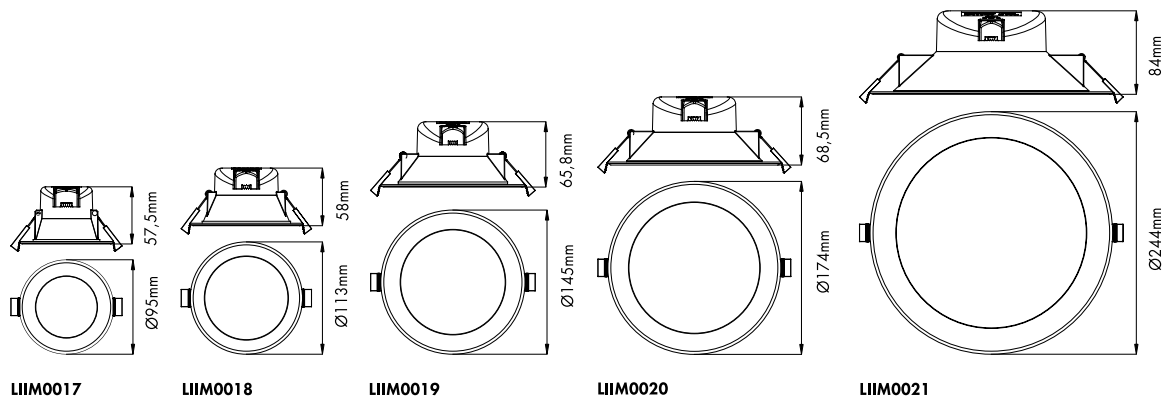

Mobil Code



LIIM0019-A



Downlights Serie SEGON ECO LED

BEZEICHNUNG	ØXH MM	AUSSCHNITT MM	VERFÜGBAR	STORE	BEST. NR.	PREG	UVP
Leuchten mit Anschlussdose							
SEGON Eco 7W Tri-weiß 3K, 4K, 6K 230V 90°, EVG, weiß	95x58	Ø68-80			LIIM0017-A	7120	18,30
SEGON Eco 9W Tri-weiß 3K, 4K, 6K 230V 90°, EVG, weiß	113x58	Ø90-102			LIIM0018-A	7120	19,80
SEGON Eco 14W Tri weiß 3K, 4K, 6K 230V 90°, EVG, weiß	145x66	Ø120-130			LIIM0019-A	7120	27,50
SEGON Eco 17W Tri weiß 3K, 4K, 6K 230V 90°, EVG, weiß	174x69	Ø145-155			LIIM0020-A	7120	32,80
SEGON Eco 25W Tri weiß 3K, 4K, 6K 230V 90°, EVG, weiß	244x84	Ø195-210			LIIM0021-A	7120	48,70

