

IPNVR/AHDVR

Prima di utilizzare questo dispositivo, leggere attentamente il presente manuale e conservarlo per future consultazioni

Please read this manual thoroughly before use and keep it for future reference

Avant d'utiliser ce dispositif, veuillez lire attentivement ce manuel et le conserver en cas de nécessité future

Lea este manual atentamente antes del uso y consérvelo para consultarlo en el futuro

Bitte lesen Sie diese Anleitung vor Gebrauch gründlich durch und bewahren Sie sie auf zum späteren Nachschlagen

Lees deze handleiding voor gebruik aandachtig door en bewaar hem voor toekomstige referentie

Por favor, leia este manual cuidadosamente antes de usar e mantenha opara referência futura

Prosimy o dokładne zapoznanie się z niniejszą instrukcją przed użyciem i zachowanie jej dla przyszłego odniesienia

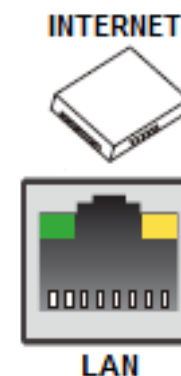
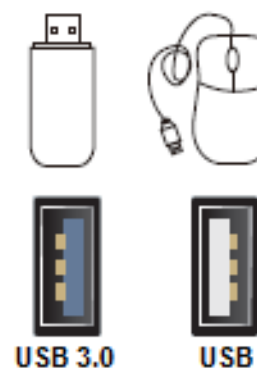
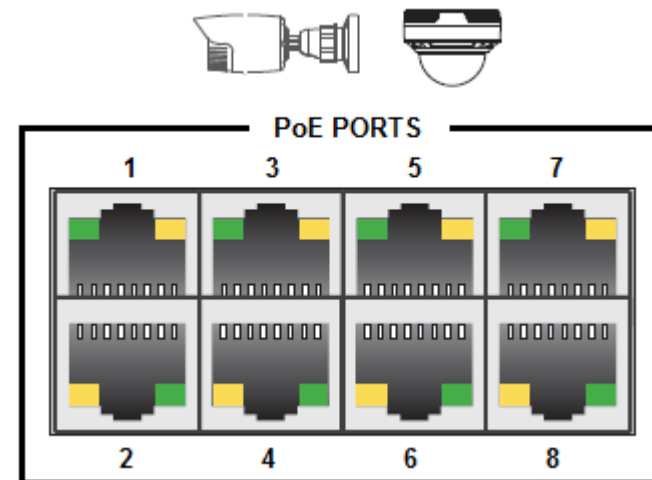
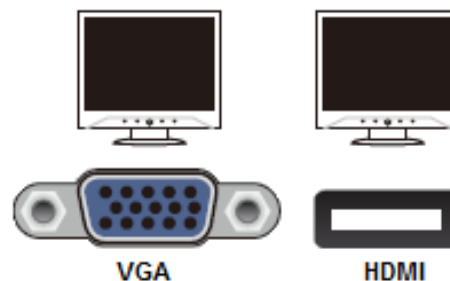
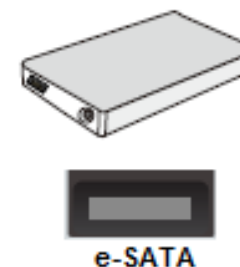
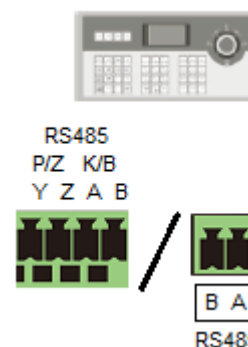
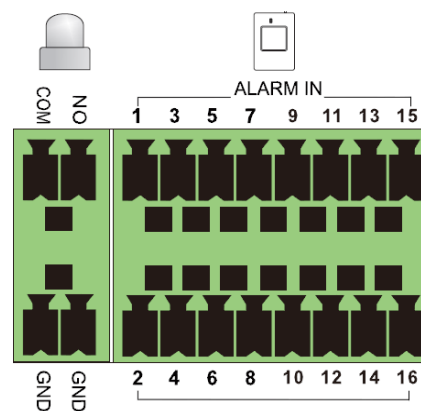

WIZARD:

Lingua / Language
Langue / Idioma
Taal / Sprache
Linguagem / Język

The screenshot shows the 'Wizard' interface with two columns: 'Language' and 'Locality'. In the 'Language' column, 'English' is selected and highlighted in green, with a circled '1' below it. In the 'Locality' column, 'Italy' is selected and highlighted in green, with a circled '2' below it. At the bottom, a red arrow points to the 'Next' button, which has a circled '3' next to it.

The screenshot shows a 'Privacy statement' screen with a scrollable text area. At the bottom, a red arrow points to a checked checkbox next to the text 'I have read and agree', with a circled '1' next to it. Another red arrow points to the 'OK' button, which has a circled '2' next to it.

Modifica data/ora
Edit date/hour
Modifier date/heure
Modificar fecha/hora
Datum/Stunde
bearbeiten
Datum/uur bewerken
Editar data/hora
Edytuj datę/godzinę

The screenshot shows the 'Wizard' interface with various system settings. The settings include: Time Zone (GMT+01 Amsterdam, Berlin, Rome, Stockl), System Time (28/10/2019 14:15:29), Date Format (Day/Month/Year), Time Format (24-Hour), DST (ON), Synchronous (NTP), NTP Server (time.windows.com), and Video Format (PAL). At the bottom, a red arrow points to the 'Next' button.

The screenshot shows the 'Wizard' interface for 'Admin Password Setup'. It includes fields for Username (admin), New Password (admin), and Confirm Password (admin). There are checkboxes for 'Display Password' (checked) and 'Log In Automatically'. A 'Pattern Lock' section has an 'Enable' checkbox (unchecked) and an 'Edit' button. At the bottom, a red arrow points to the 'Next' button.

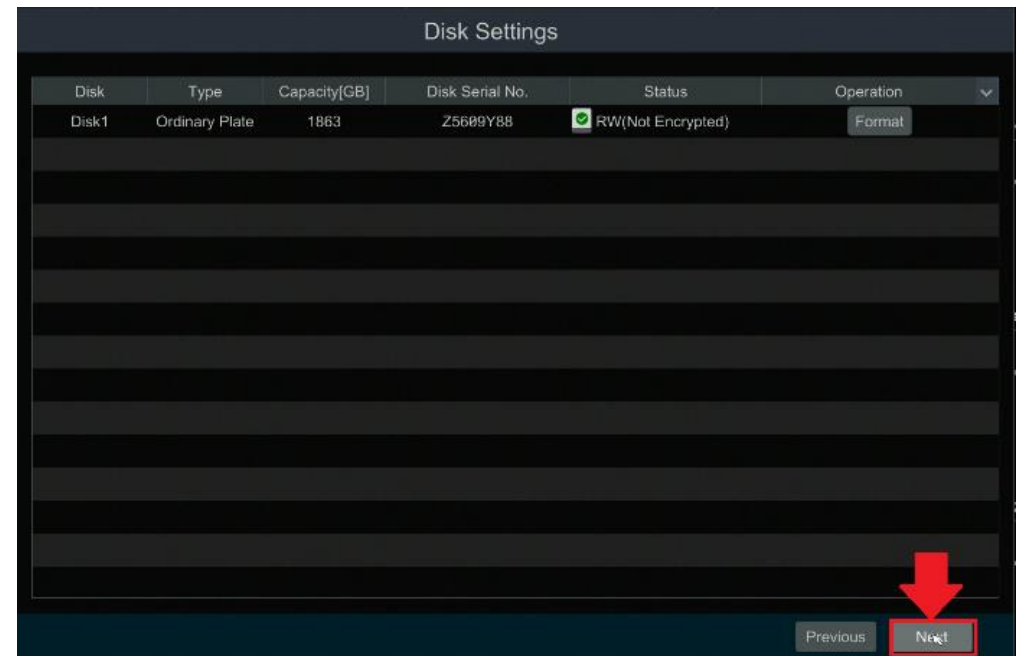
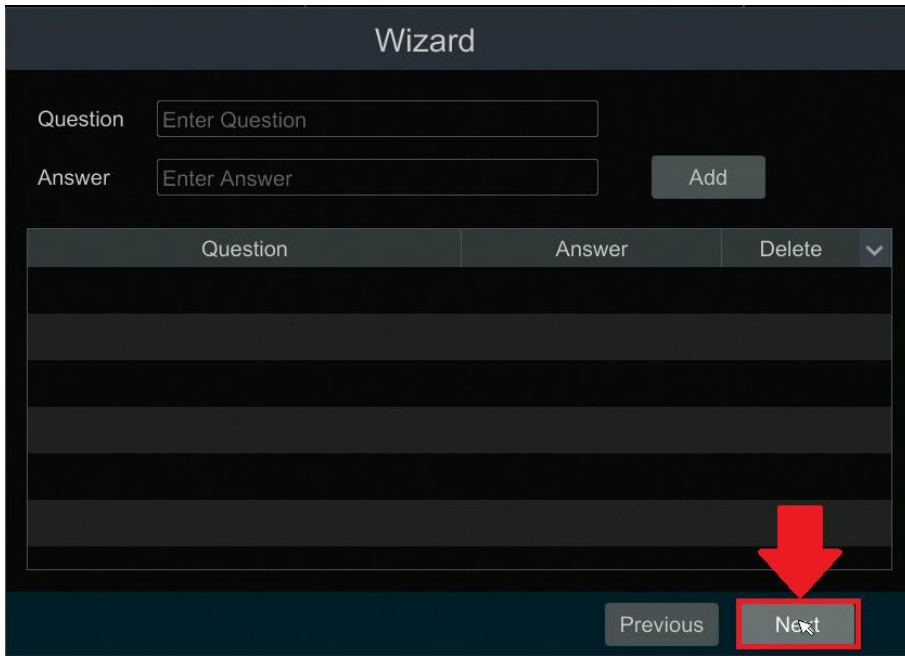

Aggiunta telecamere IP
 Add IP cameras
 Ajout de caméras IP
 Adición de cámaras IP
 Fügen Sie IP-Kameras hinzu
 IP-camera's toevoegen
 Adicionar câmeras IP
 Dodaj kamery IP

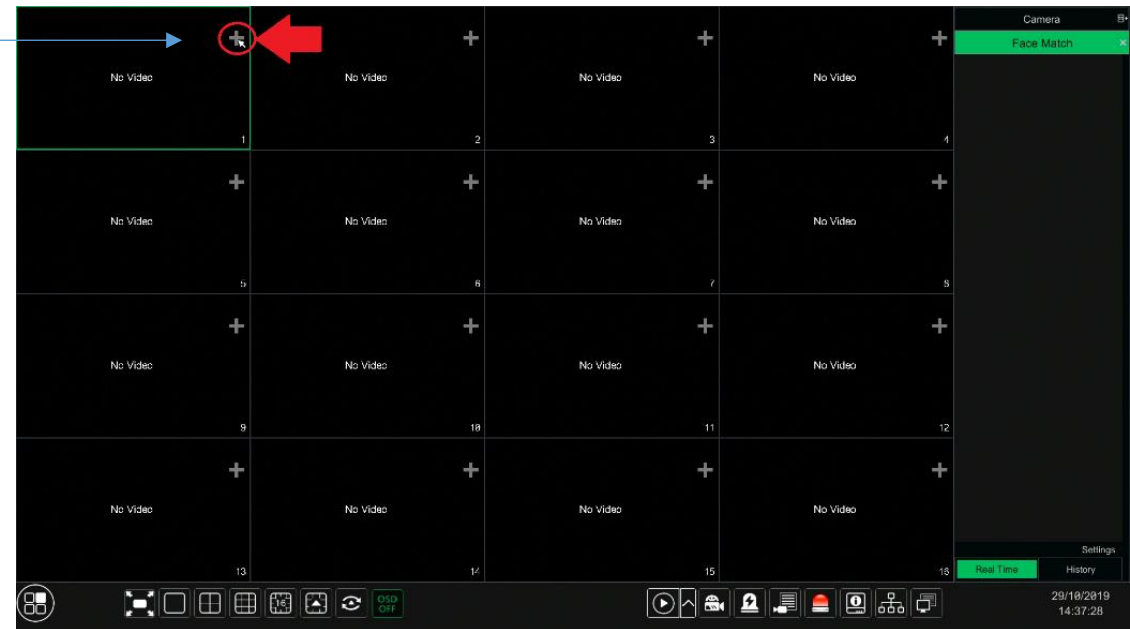

Modifica automatica indirizzi IP
 Automatic IP address change
 Changement automatique d'adresses IP
 Cambio automático de direcciones IP
 Automatische Änderung der IP-Adresse
 Automatische IP-adreswijziging
 Alteração automática de endereço IP
 Automatyczna zmiana adresu IP

Add Camera

Quickly Add Add Manually Add Recorder

<input type="checkbox"/>	No.	Address	Port	Edit	Subnet Mask	Protocol	Model
<input type="checkbox"/>	1	172.25.150.4	443	↕	0.0.0.0	ONVIF	ONVIF
<input type="checkbox"/>	2	172.25.150.5	90	↕	0.0.0.0	ONVIF	ONVIF
<input type="checkbox"/>	3	172.25.150.7	8080	↕	0.0.0.0	ONVIF	ONVIF
<input type="checkbox"/>	4	172.25.150.55	80	↕	0.0.0.0	ONVIF	ONVIF
<input type="checkbox"/>	5	172.25.150.61	9008	↕	255.255.255.0	ONVIF	ONVIF
<input type="checkbox"/>	6	172.25.150.62	9008	↕	255.255.255.0	ONVIF	ONVIF
<input type="checkbox"/>	7	172.25.150.63	9008	↕	255.255.255.0	ONVIF	ONVIF
<input type="checkbox"/>	8	172.25.150.73	8082	↕	0.0.0.0	ONVIF	ONVIF
<input type="checkbox"/>	9	172.25.150.77	8082	↕	0.0.0.0	ONVIF	ONVIF
<input type="checkbox"/>	10	172.25.150.97	8082	↕	0.0.0.0	ONVIF	ONVIF
<input type="checkbox"/>	11	172.25.150.111	80	↕	0.0.0.0	ONVIF	ONVIF
<input type="checkbox"/>	12	172.25.150.118	80	↕	0.0.0.0	ONVIF	ONVIF
<input type="checkbox"/>	13	172.25.150.119	80	↕	0.0.0.0	ONVIF	ONVIF
<input type="checkbox"/>	14	172.25.150.122	80	↕	0.0.0.0	ONVIF	ONVIF
<input type="checkbox"/>	15	192.168.1.150	9008	↕	255.255.255.0	Comelit	IPBCAMA0...

Selected: 0 / 16
Remain Bandwidth: 160 / 160 Mb

Default Password Add Cancel

Modify The Selected

Start IP

Subnet Mask

Gateway

Username

Password

- Subnet mask
- Gateway
- admin
- admin

1° indirizzo IP
 1st IP address
 1ère adresse IP
 Primera dirección IP
 1 IP-Adresse
 1e IP-adres
 1º endereço IP
 1 adres IP

WEB:

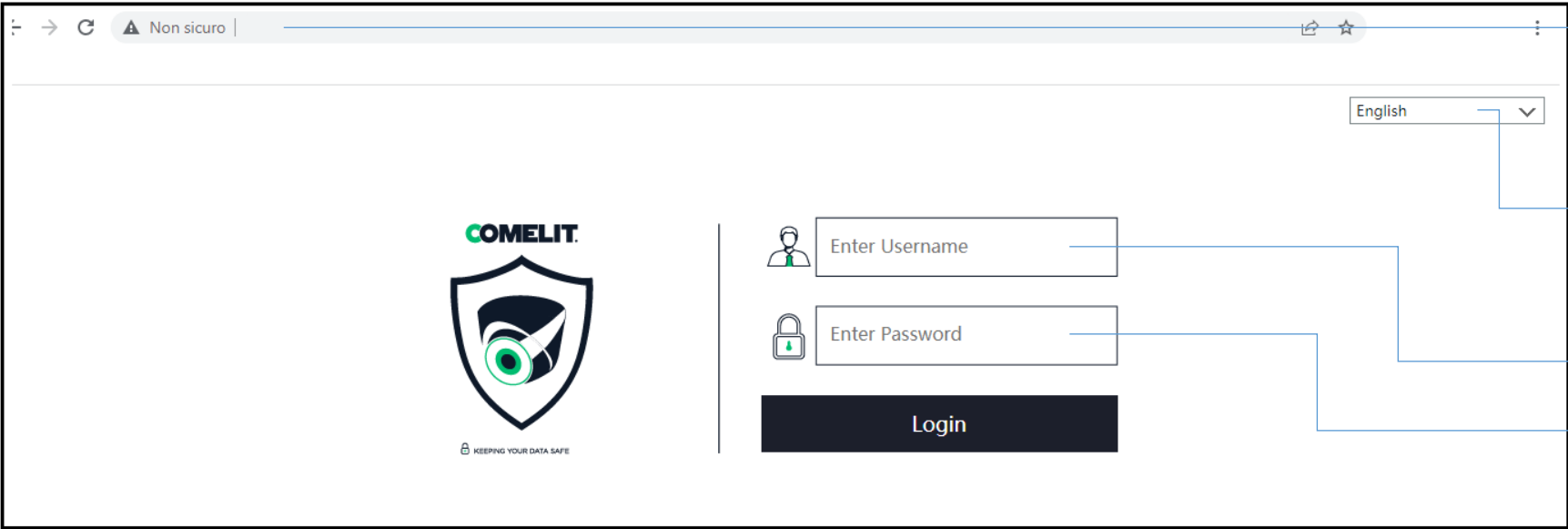

Advance series:
192.168.1.111
Next series:
DHCP

Lingua / Language
Langue / Idioma
Taal / Sprache
Linguagem / Język

admin
admin

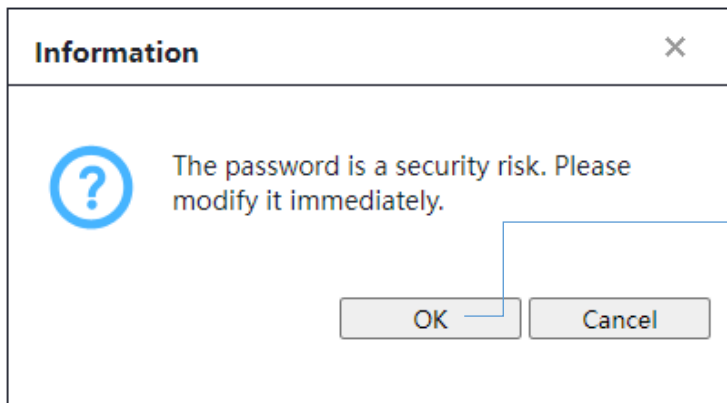

Per modificare la password di default
To change the default Password
Pour changer le mot de passe par défaut
Para cambiar la contraseña predeterminada
Zum Ändern des Standardkennworts
Het standaardwachtwoord wijzigen
Para alterar a senha padrão
Aby zmienić domyślne hasło

DOWNLOAD:

pro.comelitgroup.com → **DOWNLOAD**

Comelit Advance IP tool

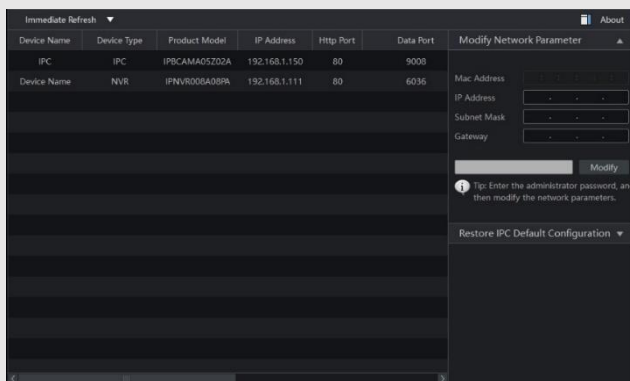

Software Comelit CCTV Manager



APP Comelit CCTV :



APP COMELIT CCTV:

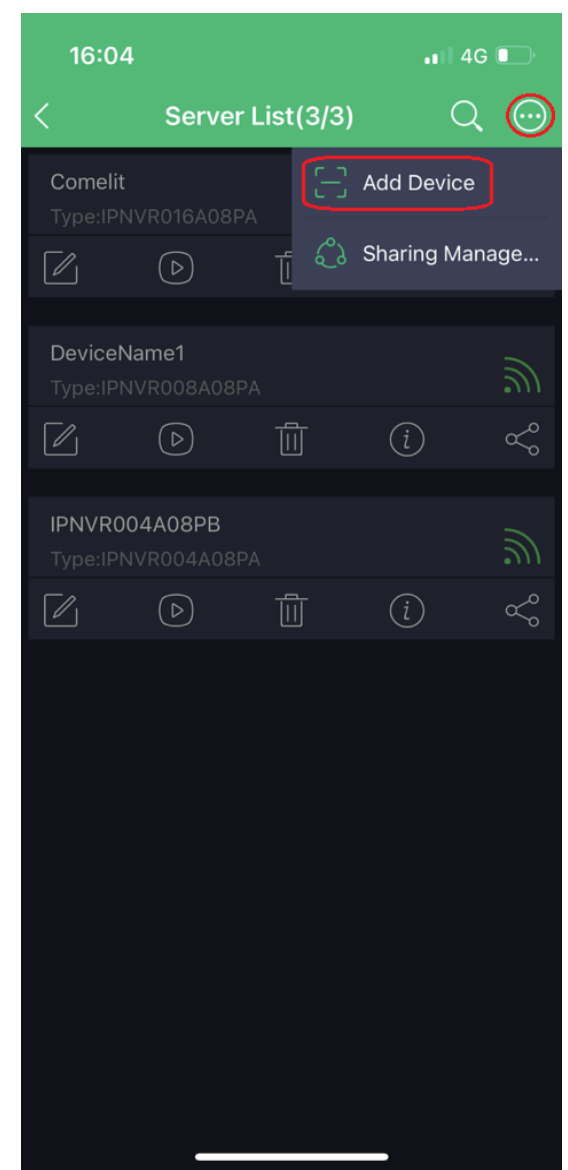
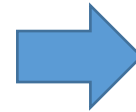
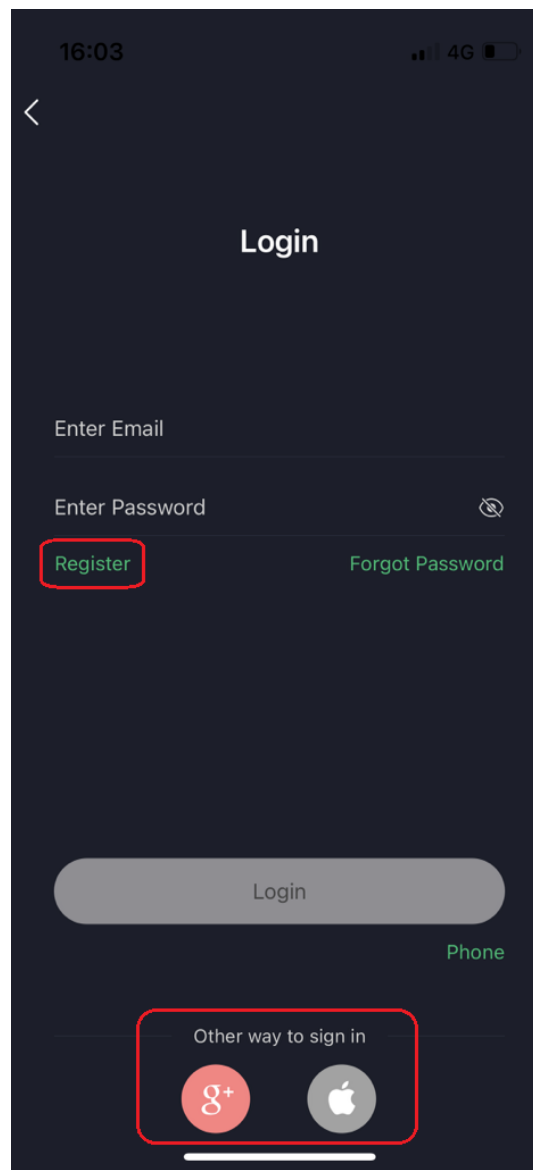
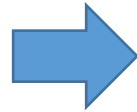
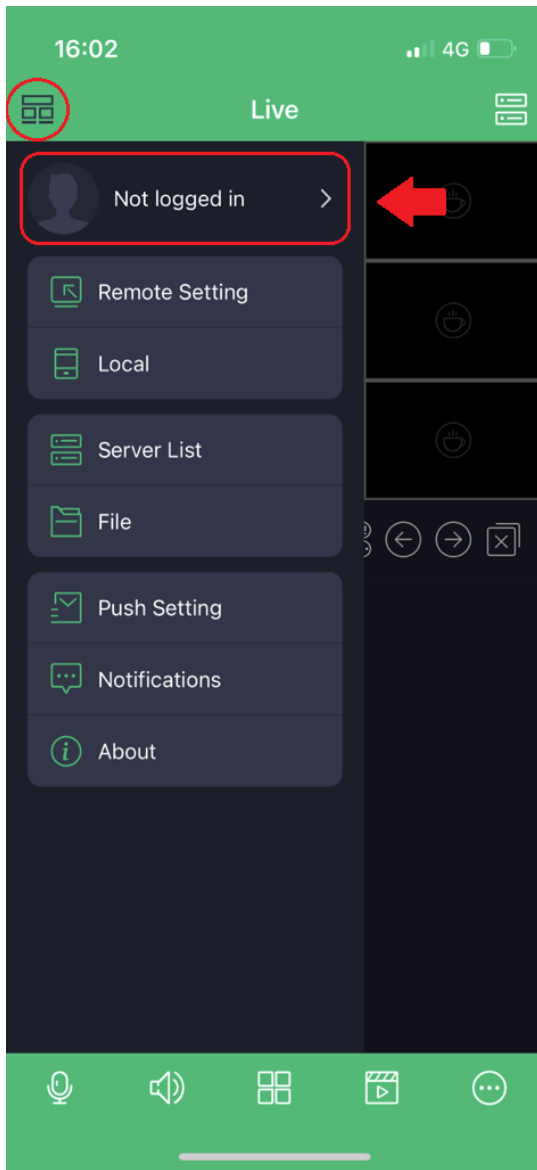

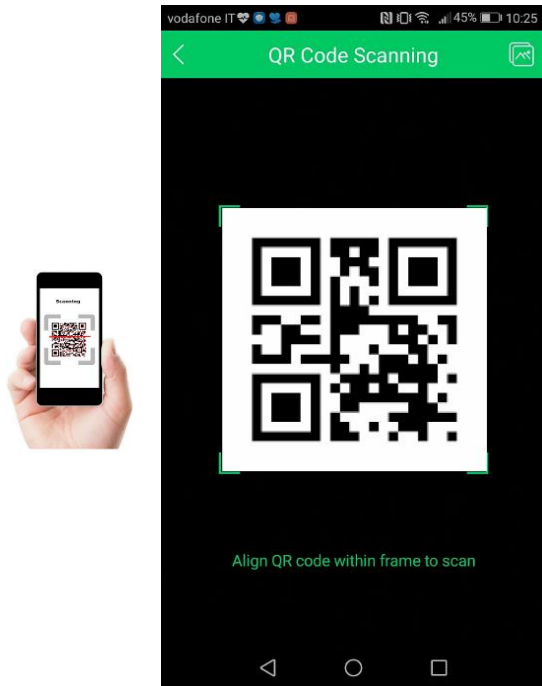

NVR menu:

- Impostazioni → Rete → P2P
- Settings → Network → P2P
- Paramètres → Réseau → P2P
- Configuraciones → Red → P2P
- Einstellungen → Netzwerk → P2P
- Instellingen → Network → P2P
- Configurações → Rede → P2P
- Ustawienia → Sieć → P2P

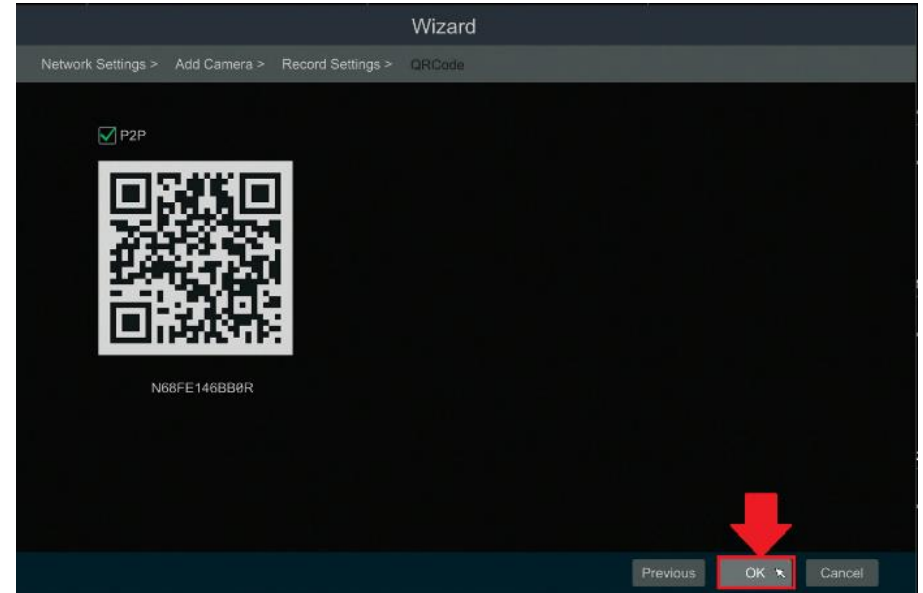

- Manuale completo
- Full manual
- Manuel complet
- Manual completo
- Volledige handleiding
- Vollständiges handbuch
- Manual completo
- Pełna instrukcja



Via Don Arrigoni, 5
24020 Rovetta (BG) - Italy