

LED Backlit Panel Serie LANO BL Modul M600 und M625, mit mikroprismatischer Abdeckung

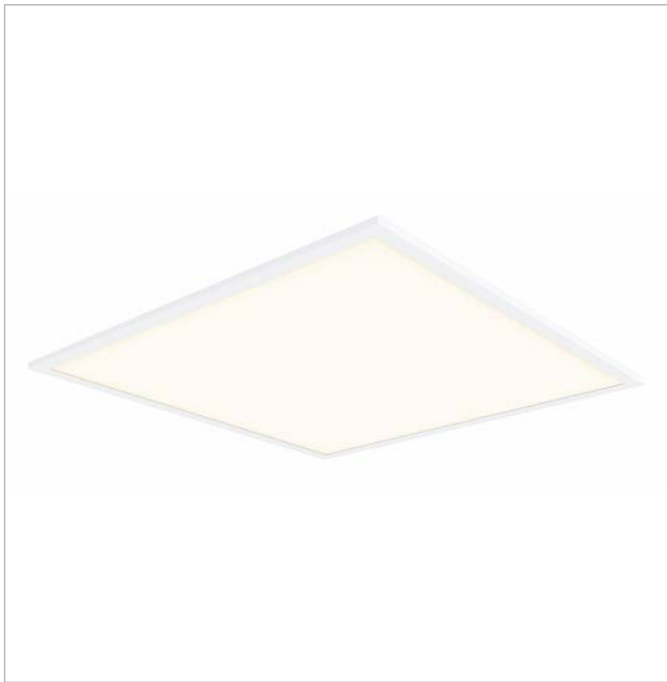

LITP0057



LITP0057--





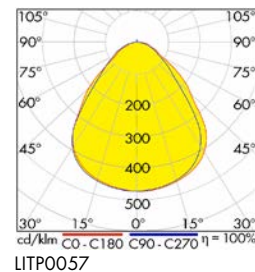
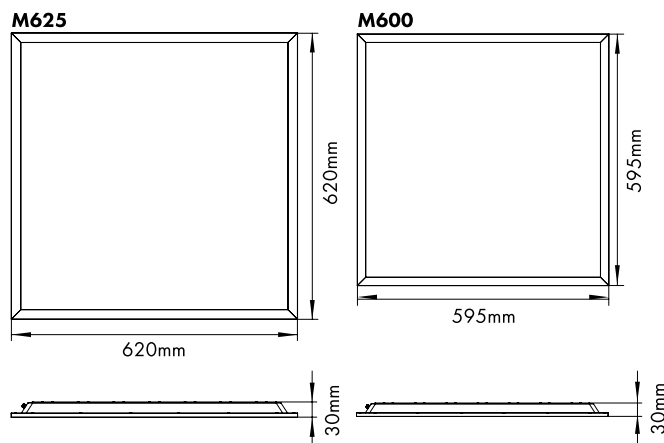

Schrack-Info

- Leuchtkörper: Stahlblech, weiß lackiert
- Abdeckung: PMMA (vergilbungsfrei), mikroprismatisch, blendfrei UGR≤19
- Farbwiedergabe: CRI≥80
- Farbtemperatur: 3000K oder 4000K
- Dimmbar: Ja (nur bei Varianten mit DALI)
- Lebensdauer: 50.000h (L70/B50)
- Umgebungstemperatur: -20°C bis +30°C
- Betriebsstrom 850mA
- Zubehör: LED Treiber, müssen separat bestellt werden
- Optionales Zubehör: Notlichteinsatz 3h und Einbaurahmen Modul M600 für Gipskartondecken
- Montage: Deckeneinbau
- Anwendungen: Büros, Besprechungsräume, Flure



Deckeneinbauleuchten

LED Backlit Panel Serie LANO BL Modul M600 und M625, mit mikroprismatischer Abdeckung

BEZEICHNUNG	LXBXH MM	VERFÜGBAR	STORE	BEST. NR.	PREG	UVP
M600						
LANO BL LED, 33W, 4300lm , 830, 850mA, M600, UGR < 19, microprism Abdeckung	595x595x30			LITP0057	7120	90,00
LANO BL LED, 33W, 4300lm , 840, 850mA, M600, UGR≤19, microprism Abdeckung	595x595x30			LITP0058	7120	90,00
M625						
LANO BL LED, 33W, 4300lm , 830, 850mA, M625, UGR≤19, microprism Abdeckung	620x620x30			LITP0053	7120	102,00
LANO BL LED, 33W, 4300lm, 840, 850mA, M625, UGR≤19, microprism Abdeckung	620x620x30			LITP0054	7120	102,00
Zubehör						
LED Treiber, 33W, 850mA, schaltbar, flickerfrei, für Serie LANO 4 LED	40x120x30			LITP0029	7120	17,30
Einbaurahmen für Gipskarton LANO LED M600	620x620x57			LIG 1000605	7120	65,30