

System functions

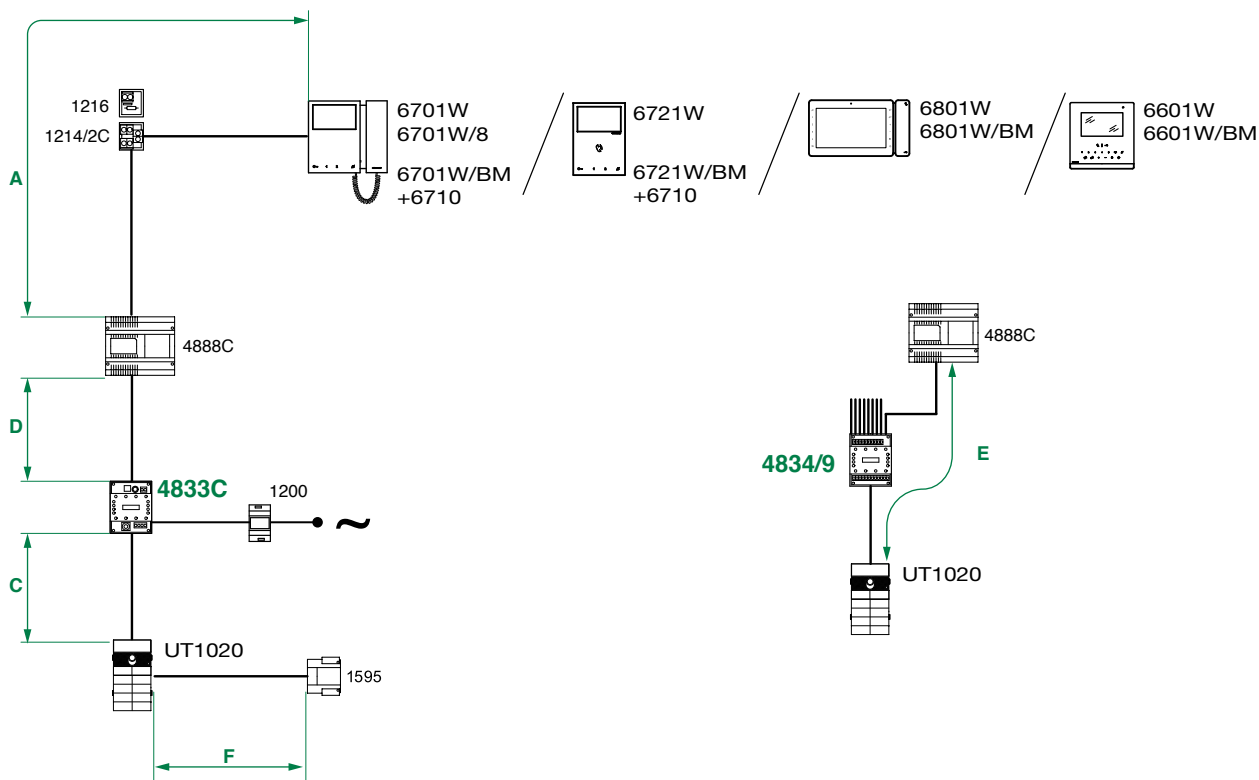

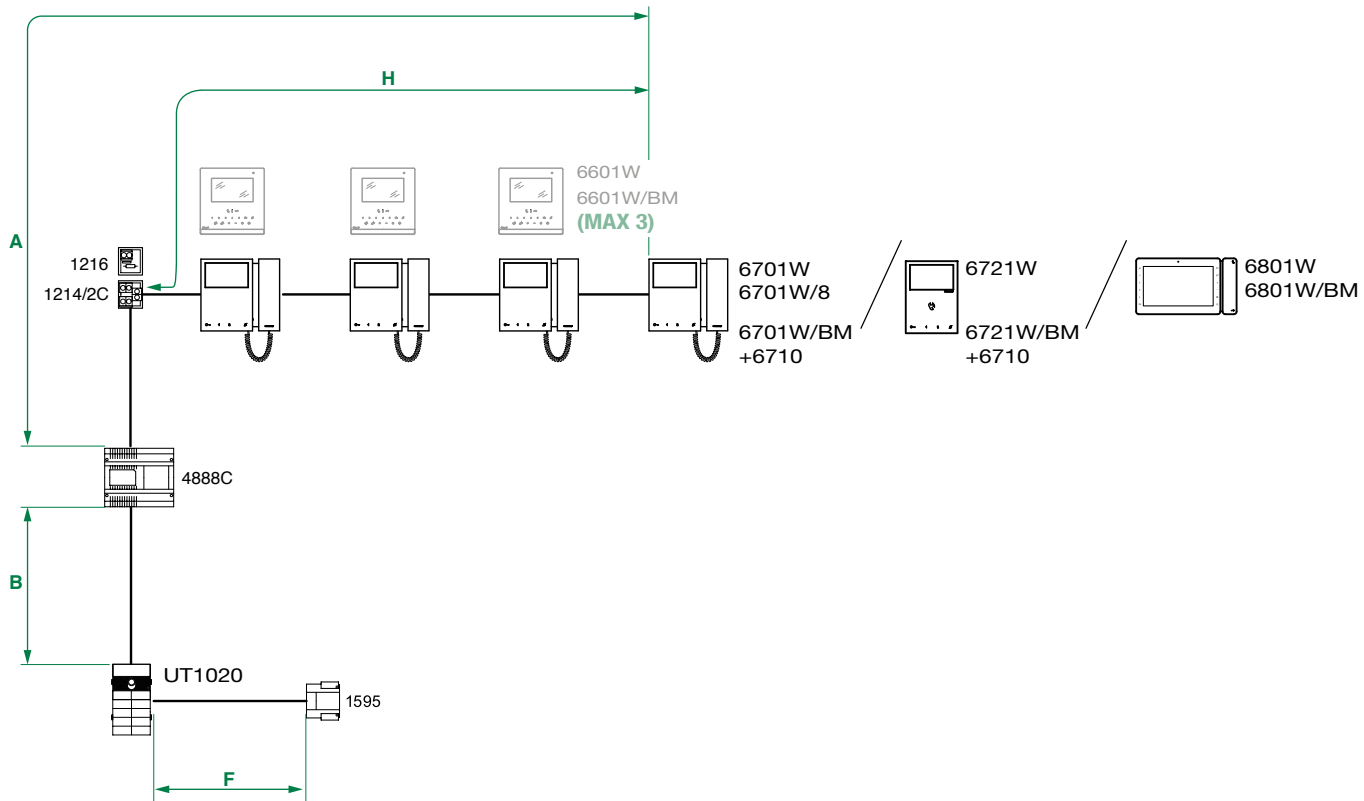

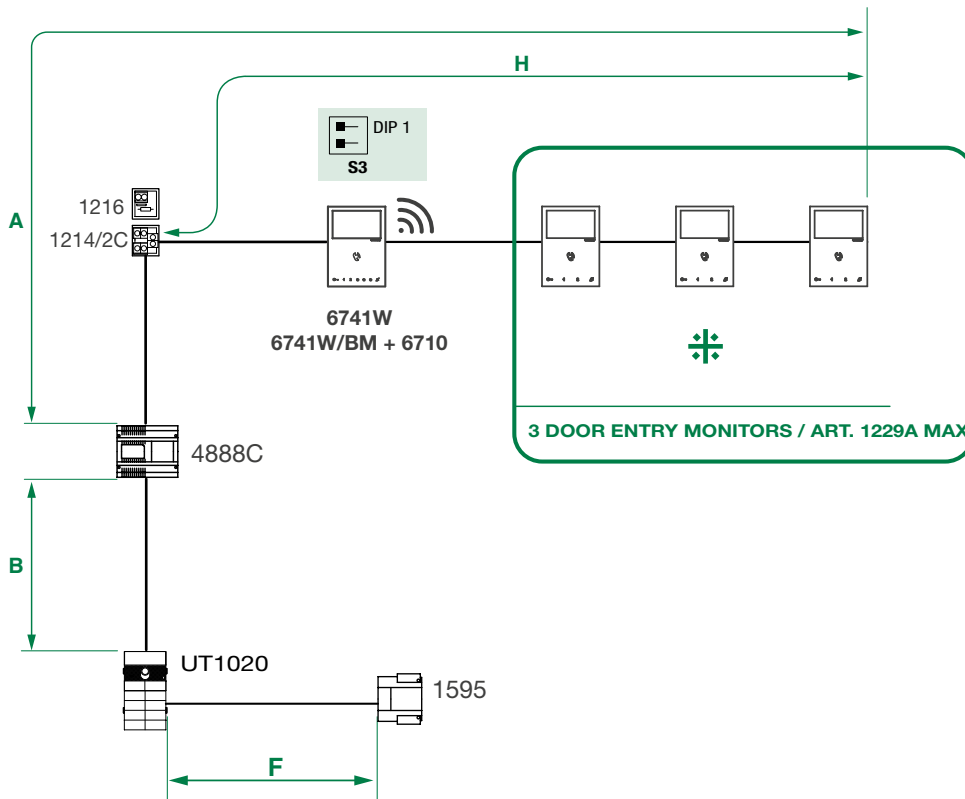





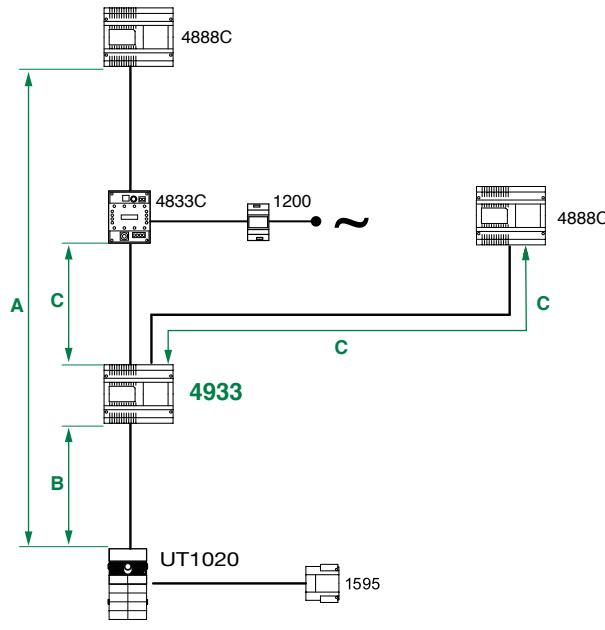

* Compatible secondary door entry monitors: 6701W (/BM), 6701W/8, 6721W (/BM), 6801W (/BM), 6601W (/BM)

Operating distances

	A MAX	B MAX	C MAX	D MAX	E MAX	F MAX	G MAX (see page 8)	H MAX	Art.1216
Comelit Art. 4577/4579 1 mm ² (Ø 1.2 mm AWG 17) 	200 m (650 feet)	200 m (650 feet)	200 m (650 feet)	200 m (650 feet)	150 m (490 feet)	50 m (165 feet)	50 m (165 feet)	100 m (330 feet)	
UTP5 cat. 5 0.2 mm ² (Ø 0.5 mm AWG 24) 	80 m (260 feet)	150 m (490 feet)	150 m (490 feet)	150 m (490 feet)	100 m (330 feet)			60 m (195 feet)	
0.28 mm ² (Ø 0.6 mm AWG 23) 	100 m (330 feet)	150 m (490 feet)	150 m (490 feet)	150 m (490 feet)	100 m (330 feet)	5 m (15 feet)	10 m (30 feet)	60 m (195 feet)	
0.5 mm ² (Ø 0.8 mm AWG 20) 	120 m (395 feet)	100 m (330 feet)	100 m (330 feet)	100 m (330 feet)	80 m (260 feet)	25 m (85 feet)	25 m (82 feet)	60 m (195 feet)	
1 mm ² (Ø 1.2 mm AWG 17) 	120 m (395 feet)	150 m (490 feet)	150 m (490 feet)	150 m (490 feet)	80 m (260 feet)	50 m (165 feet)	50 m (165 feet)	60 m (195 feet)	
1 mm ² (Ø 1.2 mm AWG 17) 	120 m (395 feet)	80 m (260 feet)	80 m (260 feet)	80 m (260 feet)	50 m (165 feet)	50 m (165 feet)	50 m (165 feet)	40 m (130 feet)	
1.5 mm ² (Ø 1.4 mm AWG 15) 	150 m (490 feet)	100 m (330 feet)	100 m (330 feet)	100 m (330 feet)	80 m (260 feet)	75 m (245 feet)	100 m (330 feet)	60 m (195 feet)	
2.5 mm ² (Ø 1.8 mm AWG 13) 	150 m (490 feet)	100 m (330 feet)	100 m (330 feet)	100 m (330 feet)	80 m (260 feet)	100 m (330 feet)	150 m (490 feet)	60 m (195 feet)	

Distances with video concentrator-amplifier Art. 4933



	A MAX *	B MAX	C MAX	
			NORMAL GAIN	HIGH GAIN
Comelit Art. 4577/4579 1 mm ² (Ø 1.2 mm AWG 17) 	600 m (1965 feet)	200 m (655 feet)	300 m (985 feet)	600 m (1965 feet)
Comelit Art. 4576/4578 0.5 mm ² (Ø 0.8 mm AWG 20) 	300 m (985 feet)	200 m (655 feet)	300 m (985 feet)	600 m (1965 feet)
UTP5 cat. 5 0.2 mm ² (Ø 0.5 mm AWG 24) 	150 m (495 feet)	150 m (495 feet)	200 m (655 feet)	300 m (985 feet)
0.28 mm ² (Ø 0.6 mm AWG 23) 	200 m (655 feet)	150 m (495 feet)	200 m (655 feet)	300 m (985 feet)
0.5 mm ² (Ø 0.8 mm AWG 20) 	300 m (985 feet)	100 m (325 feet)	200 m (655 feet)	300 m (985 feet)
1 mm ² (Ø 1.2 mm AWG 17) 	600 m (1965 feet)	150 m (495 feet)	200 m (655 feet)	300 m (985 feet)
1 mm ² (Ø 1.2 mm AWG 17) 	600 m (1965 feet)	80 m (260 feet)	100 m (325 feet)	150 m (495 feet)
1.5 mm ² (Ø 1.4 mm AWG 15) 	700 m (2295 feet)	100 m (325 feet)	200 m (655 feet)	300 m (985 feet)

* For greater distances, please contact **Comelit Group S.p.A.** for information on using the data amplifier Art. 1236, to be installed before Art. 4933.